

B (1:1)

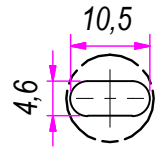

C (1:1)

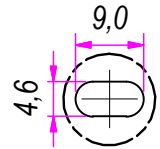

D (1:1)

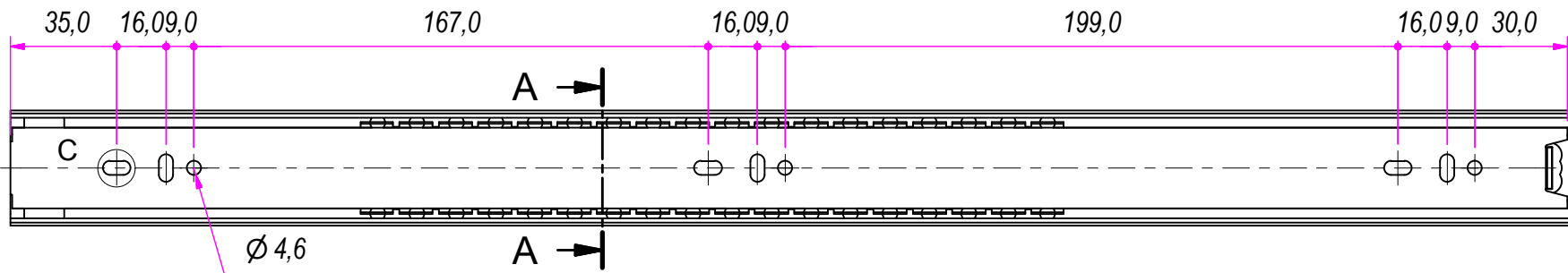
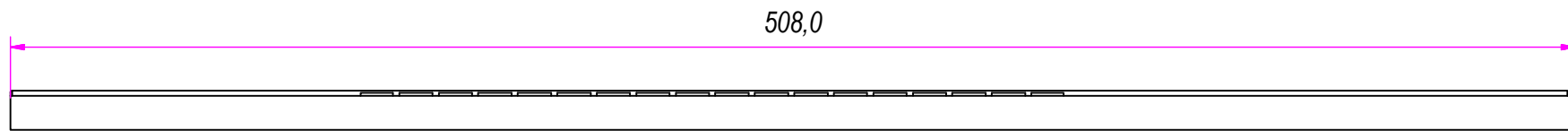
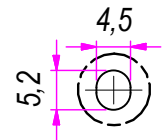

SEZ. A-A

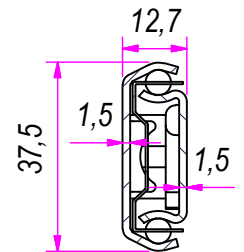

REVISION HISTORY			
REV	DESCRIPTION	APPROVED BY	DATE
1		F.Dino	02/02/2017

DESIGNED BY F.Dino	CHECKED AND APPROVED BY L. Paleari	DATE 02/02/2017	CODE 35500
		GENERAL TOLLERANCE SS-ISO-2768-1M	UNIT mm
		DESCRIPTION	MATERIAL Cold rolled steel
DEVICE		PAIR WEIGHT 1,116 Kg	SHEET 1 of 2

Property of RAM Industrie.
Without its written authorization the present drawing shall neither be used for construction anyway, communicated to third parties, nor reproduced.

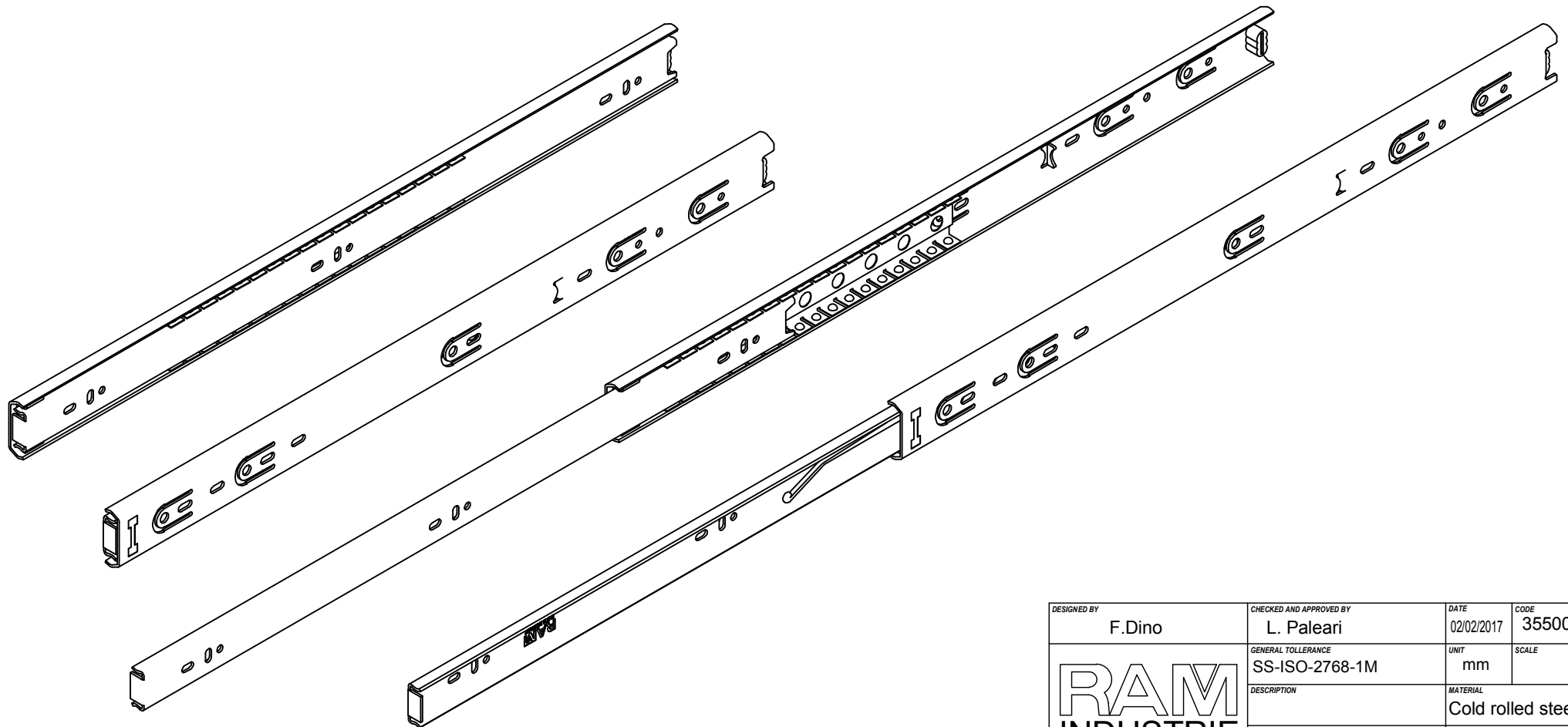
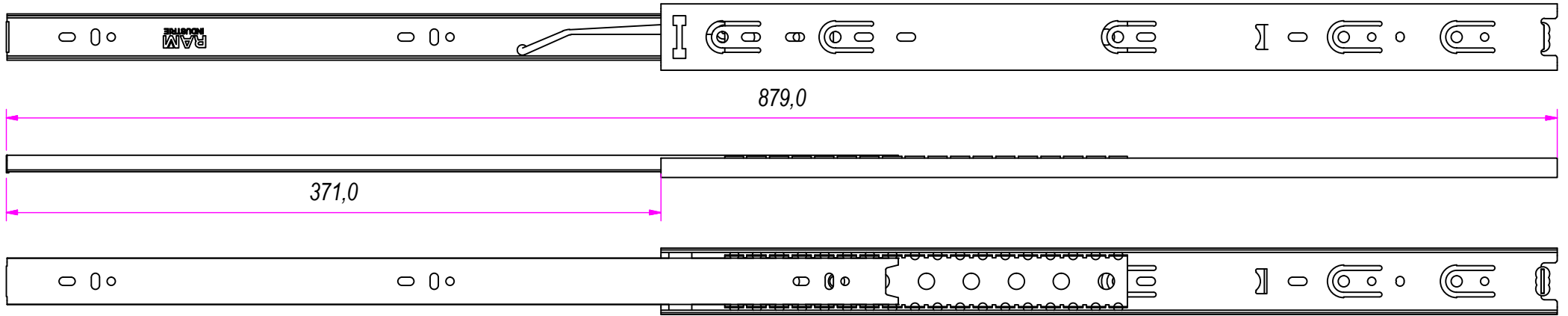

REVISION HISTORY			
REV	DESCRIPTION	APPROVED BY	DATE
1		F.Dino	02/02/2017

DESIGNED BY F.Dino	CHECKED AND APPROVED BY L. Paleari	DATE 02/02/2017	CODE 35500	
		GENERAL TOLLERANCE SS-ISO-2768-1M	UNIT mm	SCALE SHEET 2 of 2
		DESCRIPTION	MATERIAL Cold rolled steel	
DEVICE	PAIR WEIGHT 1,116 Kg		03T	

Property of RAM Industrie.
Without its written authorization the present drawing shall neither be used for construction anyway, communicated to third parties, nor reproduced.