

SEZ. A-A

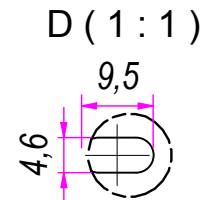

DESIGNED BY F.Dino	CHECKED AND APPROVED BY L. Paleari	REVISION	DATE 04/08/2016	CODE 51450
GENERAL TOLERANCE SS-ISO-2768-1M		UNIT mm	SCALE	SHEET 1 of 2
DESCRIPTION			MATERIAL Cold rolled steel	
DEVICE			PAIR WEIGHT 2,152 Kg	03T
Property of RAM Industrie. Without its written authorization the present drawing shall neither be used for construction anyway, communicated to third parties, nor reproduced.				

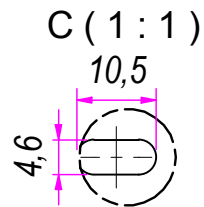

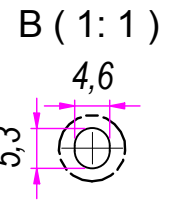
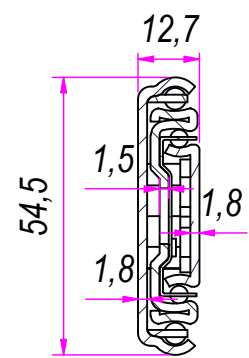
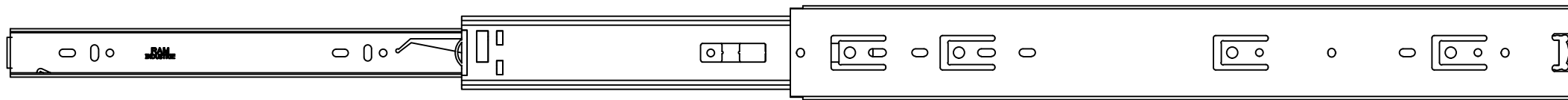

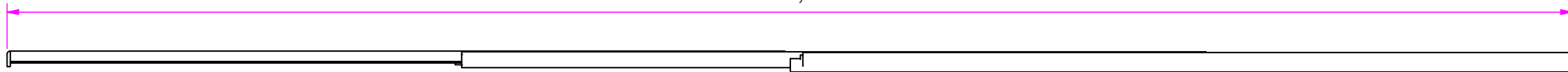

916,0

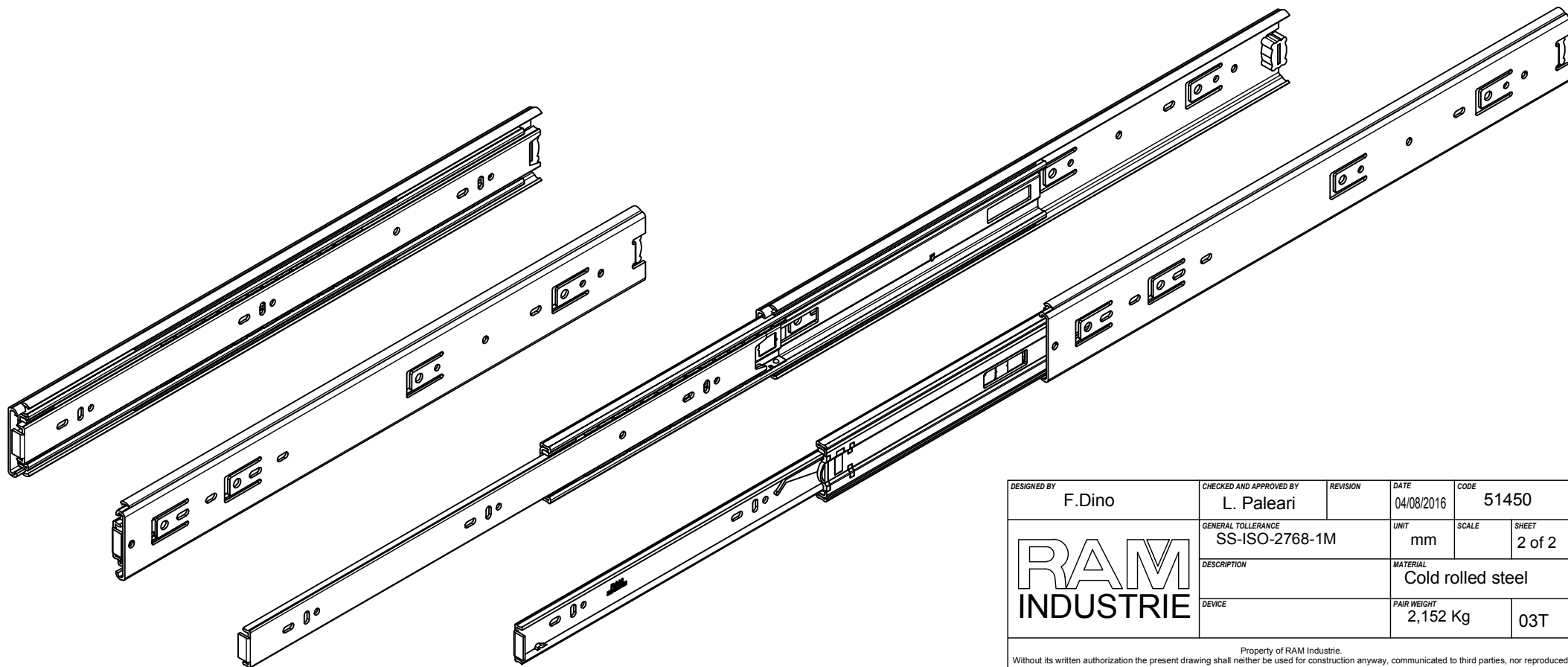
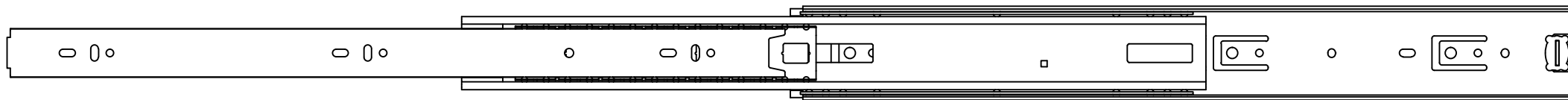

459,0



DESIGNED BY F.Dino	CHECKED AND APPROVED BY L. Paleari	REVISION	DATE 04/08/2016	CODE 51450
		GENERAL TOLLERANCE SS-ISO-2768-1M	UNIT mm	SCALE SHEET 2 of 2
		DESCRIPTION	MATERIAL Cold rolled steel	
DEVICE	PAIR WEIGHT 2,152 Kg		03T	

Property of RAM Industrie.  
Without its written authorization the present drawing shall neither be used for construction anyway, communicated to third parties, nor reproduced.