

711,0

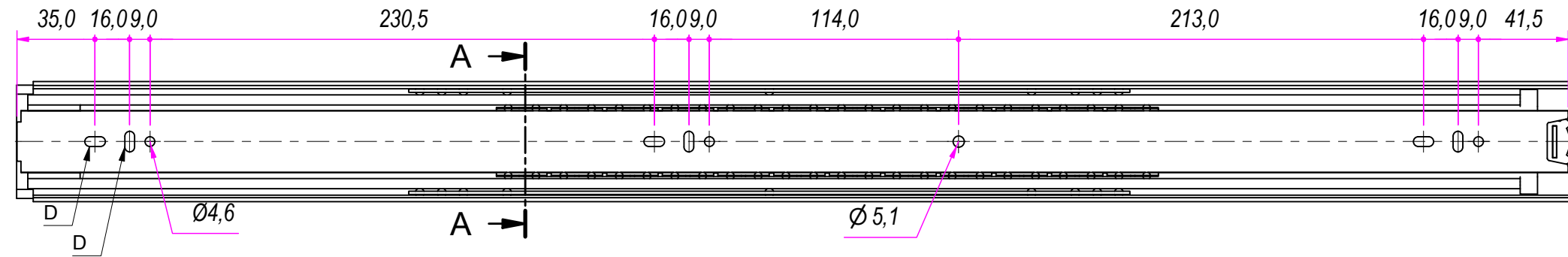

SEZ. A-A

B (1:1)

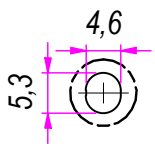

C (1:1)

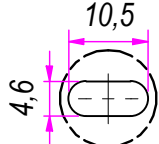

D (1:1)

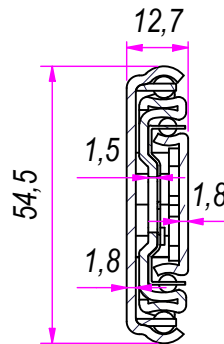
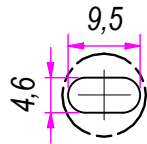

DESIGNED BY F.Dino	CHECKED AND APPROVED BY L. Paleari	REVISION	DATE 04/08/2016	CODE 51700
GENERAL TOLERANCE SS-ISO-2768-1M			UNIT mm	SCALE 1 of 2
DESCRIPTION			MATERIAL Cold rolled steel	
DEVICE			PAIR WEIGHT 3,356 Kg	03T

Property of RAM Industrie.
Without its written authorization the present drawing shall neither be used for construction anyway, communicated to third parties, nor reproduced.

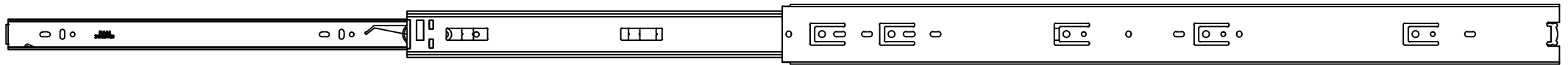

1423,0

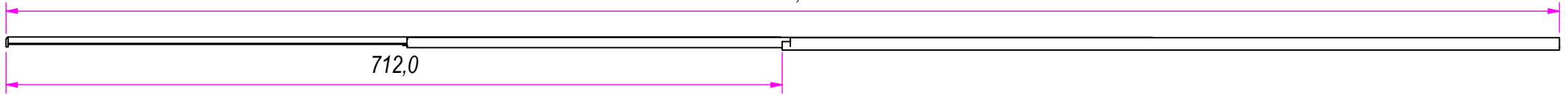

712,0

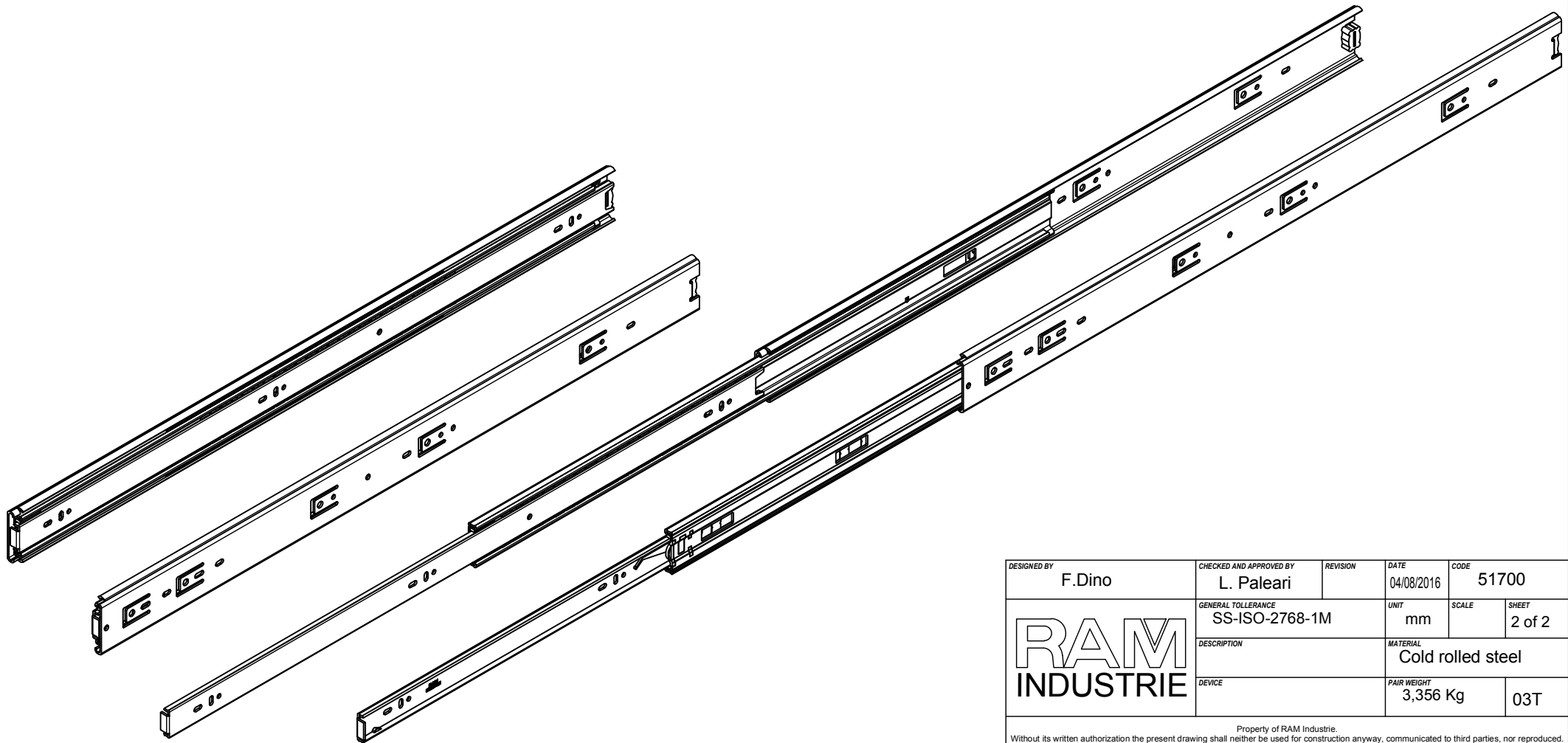
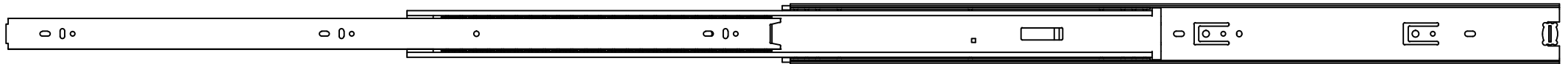

DESIGNED BY F.Dino	CHECKED AND APPROVED BY L. Paleari	REVISION	DATE 04/08/2016	CODE 51700
		GENERAL TOLLERANCE SS-ISO-2768-1M	UNIT mm	SCALE 2 of 2
		DESCRIPTION	MATERIAL Cold rolled steel	
DEVICE	PAIR WEIGHT 3,356 Kg	03T		

Property of RAM Industrie.
Without its written authorization the present drawing shall neither be used for construction anyway, communicated to third parties, nor reproduced.