

SEZ. A-A

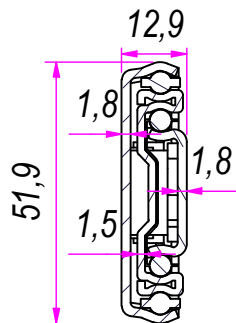

D (1:1)

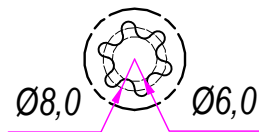

C (1:1)

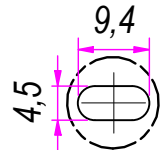

B (1:1)

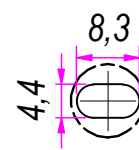

REVISION HISTORY			
REV	DESCRIPTION	APPROVED BY	DATE
1		F.Dino	18/10/2016

DESIGNED BY F.Dino	CHECKED AND APPROVED BY L. Paleari	DATE 18/10/2016	CODE 55650
GENERAL TOLLERANCE SS-ISO-2768-1M		UNIT mm	SCALE 1 of 2
DESCRIPTION Soft-Self closing with double-spring		MATERIAL Cold rolled steel	
		PAIR WEIGHT 2,798 Kg	01T

RAM
INDUSTRIE

Property of RAM Industrie.
Without its written authorization the present drawing shall neither be used for construction anyway, communicated to third parties, nor reproduced.

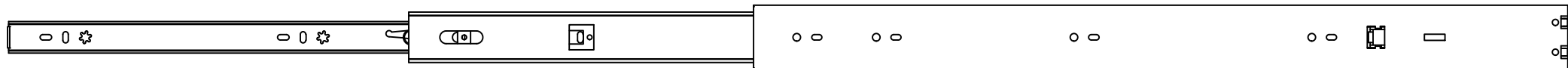

1265,0

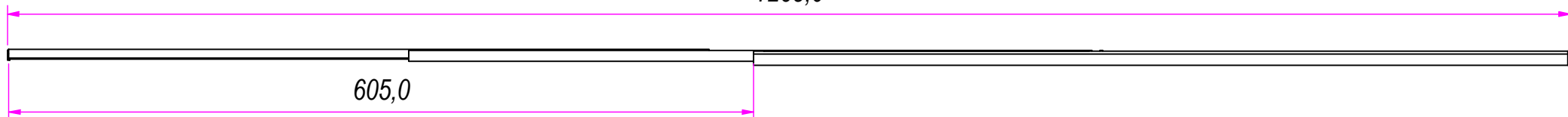

605,0

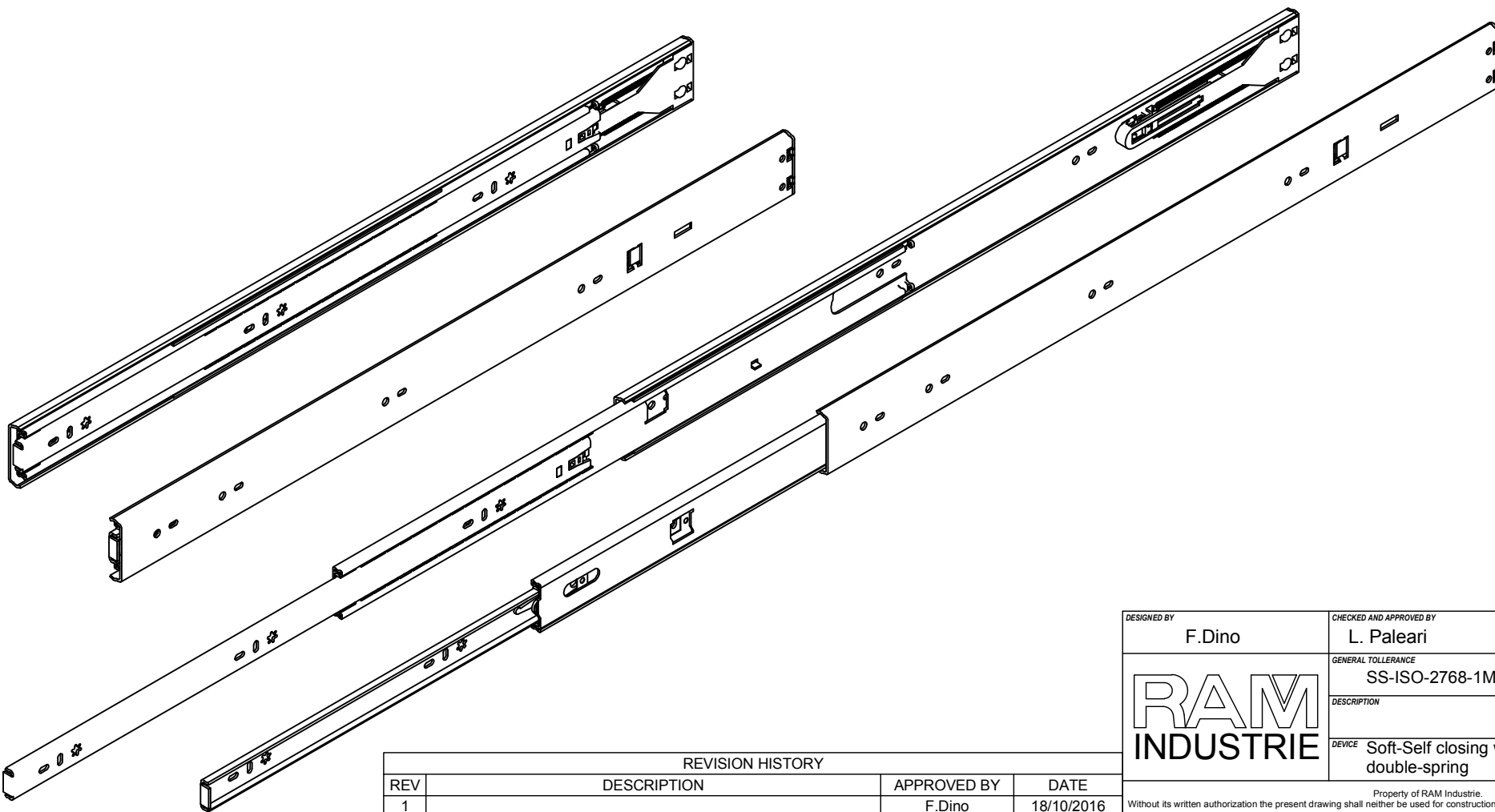
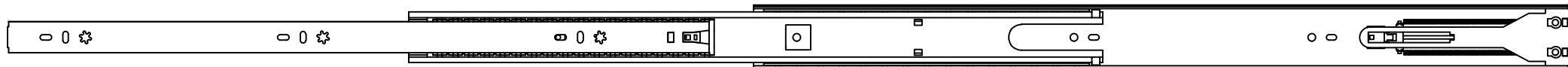

REVISION HISTORY			
REV	DESCRIPTION	APPROVED BY	DATE
1		F.Dino	18/10/2016

DESIGNED BY F.Dino	CHECKED AND APPROVED BY L. Paleari	DATE 18/10/2016	CODE 55650	
		GENERAL TOLLERANCE SS-ISO-2768-1M	UNIT mm	SCALE 2 of 2
		DESCRIPTION Soft-Self closing with double-spring	MATERIAL Cold rolled steel	PAIR WEIGHT 2,798 Kg

Property of RAM Industrie.
Without its written authorization the present drawing shall neither be used for construction anyway, communicated to third parties, nor reproduced.