

SEZ. A-A

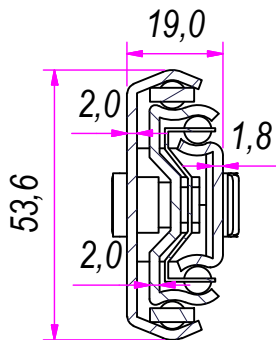

B (1 : 1.5)

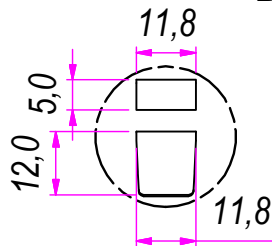

C (1 : 1.5)

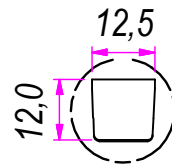

D (1 : 1)

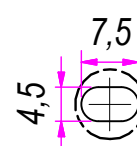

REVISION HISTORY			
REV	DESCRIPTION	APPROVED BY	DATE
1		F.Dino	15/11/2016

DESIGNED BY F.Dino	CHECKED AND APPROVED BY L. Paleari	DATE 15/11/2016	CODE 59550
GENERAL TOLLERANCE SS-ISO-2768-1M		UNIT mm	SCALE 1 of 2
DESCRIPTION Bayonet side mounting		MATERIAL Cold rolled steel	
DEVICE		PAIR WEIGHT 2,986 Kg	02C

RAM
INDUSTRIE

Property of RAM Industrie.
Without its written authorization the present drawing shall neither be used for construction anyway, communicated to third parties, nor reproduced.

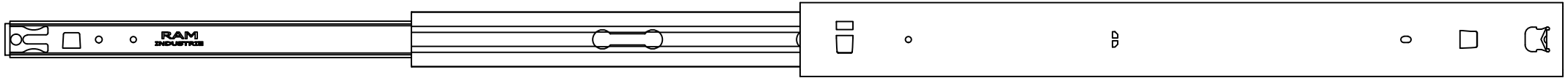

1124,0

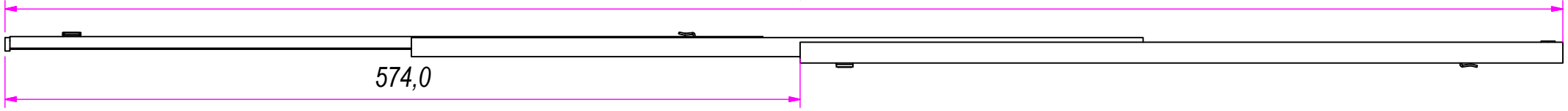

574,0

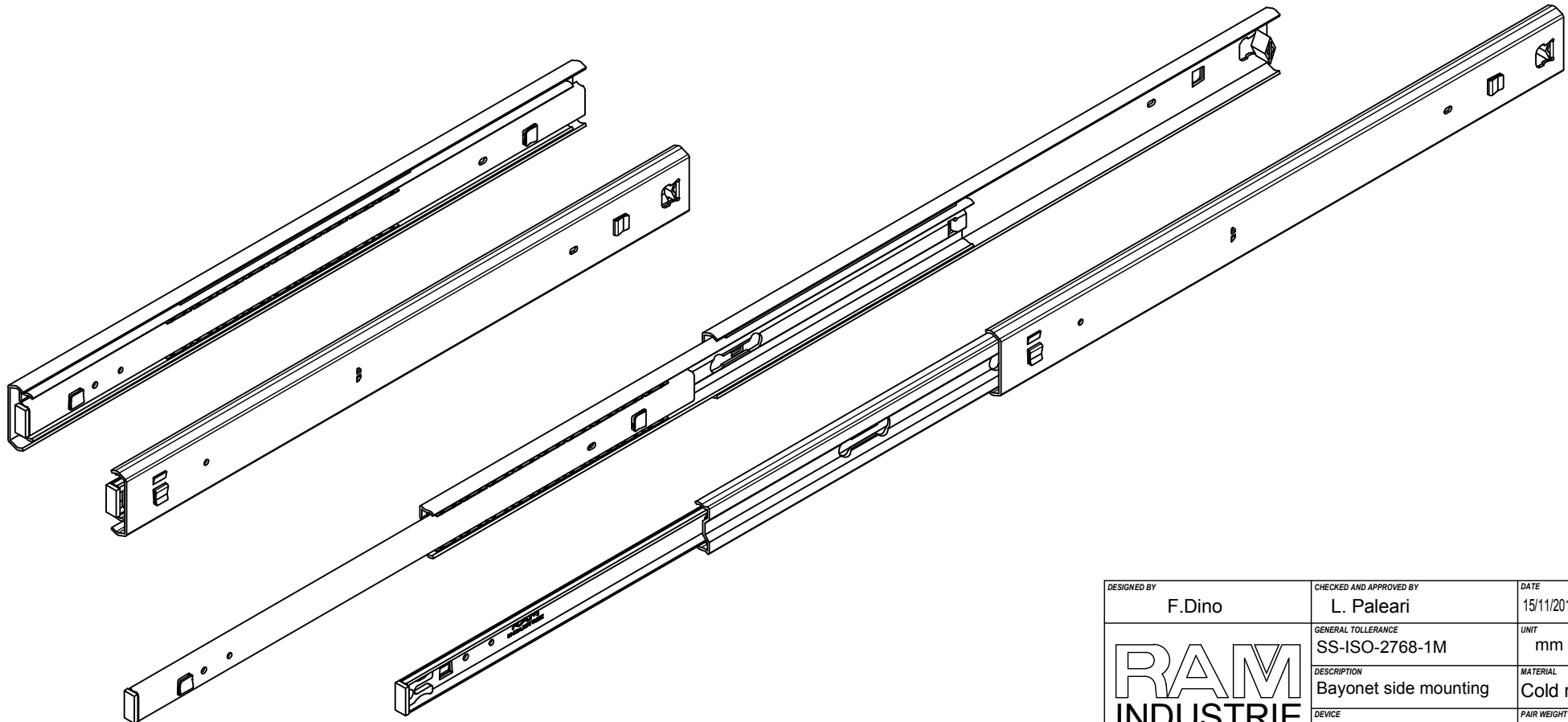
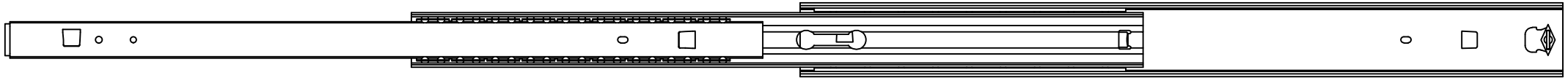

REVISION HISTORY			
REV	DESCRIPTION	APPROVED BY	DATE
1		F.Dino	15/11/2016

DESIGNED BY F.Dino	CHECKED AND APPROVED BY L. Paleari	DATE 15/11/2016	CODE 59550		
		GENERAL TOLLERANCE SS-ISO-2768-1M	UNIT mm	SCALE	SHEET 2 of 2
		DESCRIPTION Bayonet side mounting	MATERIAL Cold rolled steel	PAIR WEIGHT 2,986 Kg	02C

Property of RAM Industrie.
Without its written authorization the present drawing shall neither be used for construction anyway, communicated to third parties, nor reproduced.