

SEZ. A-A

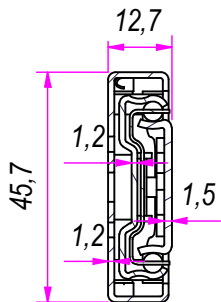

B (1:1)

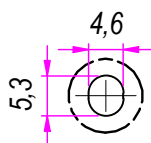

C (1:1)

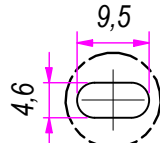

D (1:1)

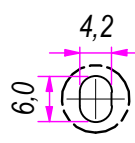

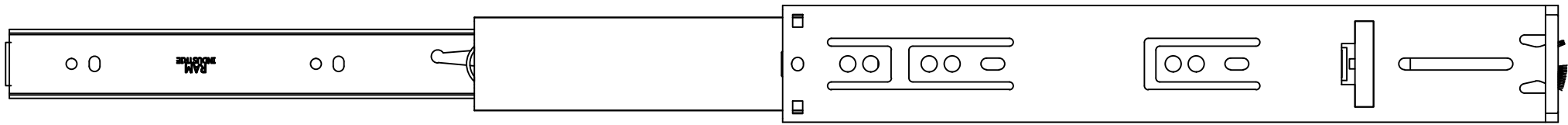

DESIGNED BY F.Dino	CHECKED AND APPROVED BY L. Paleari	REVISION	DATE 18/05/2016	CODE 60300
		GENERAL TOLLERANCE SS-ISO-2768-1M	UNIT mm	SCALE 1 of 2
		DESCRIPTION Self closing with double-spring	MATERIAL Cold rolled steel	
DEVICE		PAIR WEIGHT 0,838 Kg	03T	

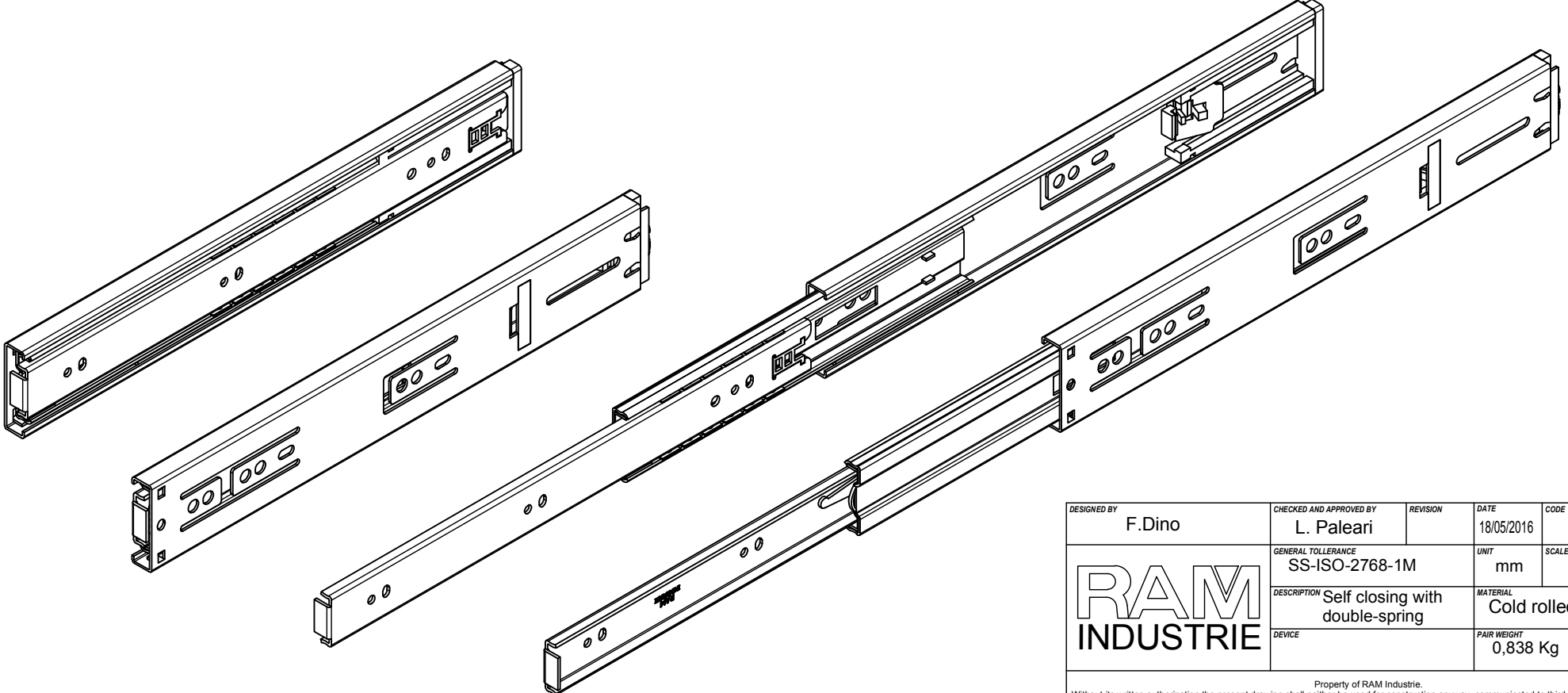
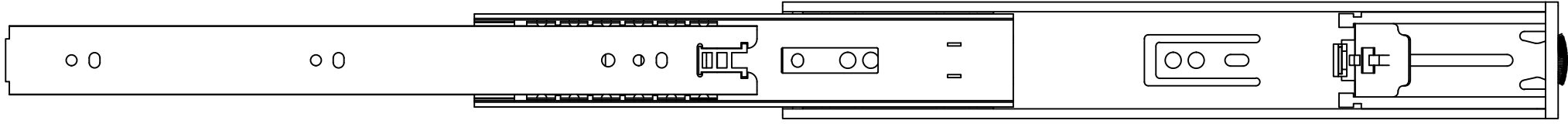

612,0

307,0



DESIGNED BY F.Dino	CHECKED AND APPROVED BY L. Paleari	REVISION	DATE 18/05/2016	CODE 60300
		GENERAL TOLLERANCE SS-ISO-2768-1M	UNIT mm	SCALE SHEET 2 of 2
		DESCRIPTION Self closing with double-spring	MATERIAL Cold rolled steel	
DEVICE		PAIR WEIGHT 0,838 Kg	03T	

Property of RAM Industrie.
Without its written authorization the present drawing shall neither be used for construction anyway, communicated to third parties, nor reproduced.