

B (1:1)

C (1:1)

D (1:1)

E (1:1)

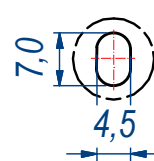
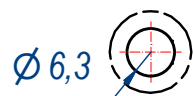
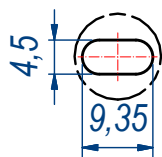

DESIGNED BY F.Dino	CHECKED AND APPROVED BY L. Paleari	REVISION	DATE 26/01/2016	CODE 62250
GENERAL TOLERANCE SS-ISO-2768-1M			UNIT mm	SCALE 1 of 2
DESCRIPTION Self closing			MATERIAL Zinc coated steel	
			PAIR WEIGHT 0,54 Kg	02T

Property of RAM Industrie.
Without its written authorization the present drawing shall neither be used for construction anyway, communicated to third parties, nor reproduced.

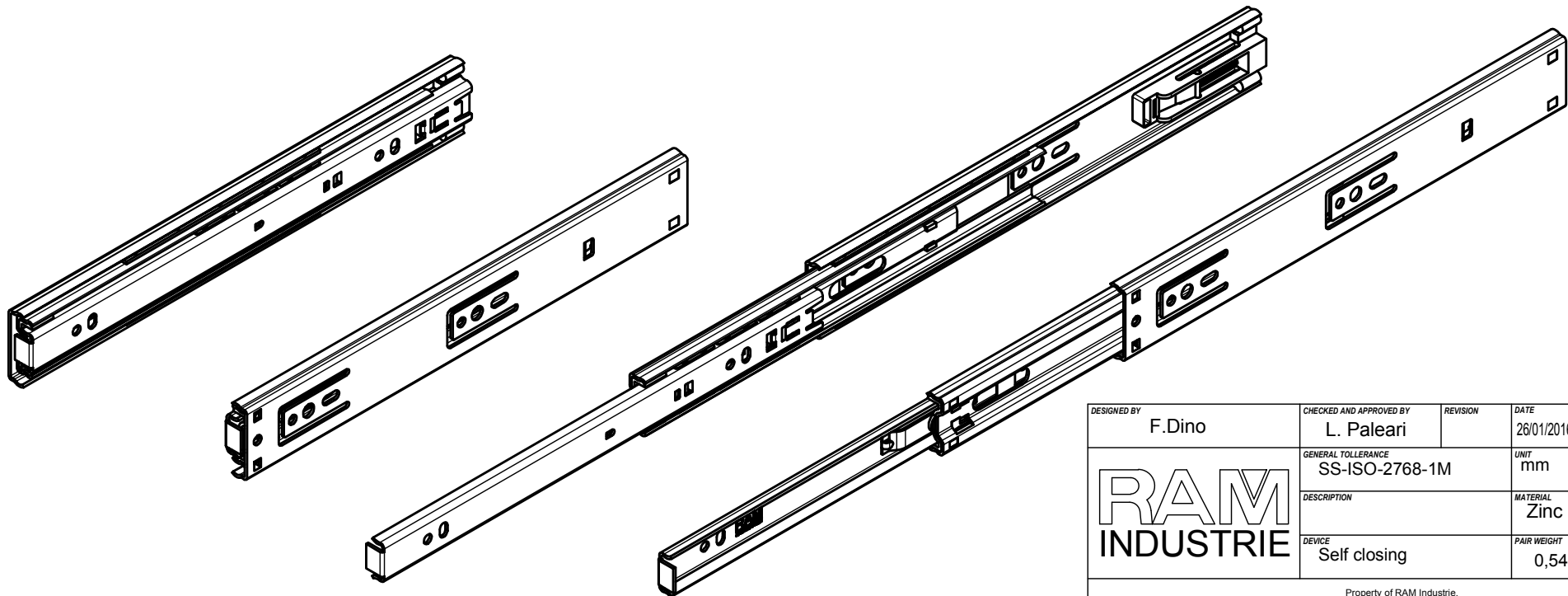
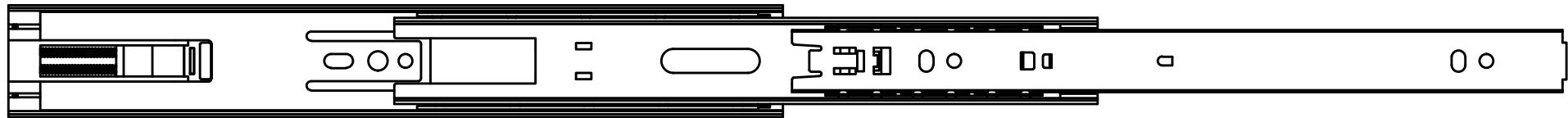
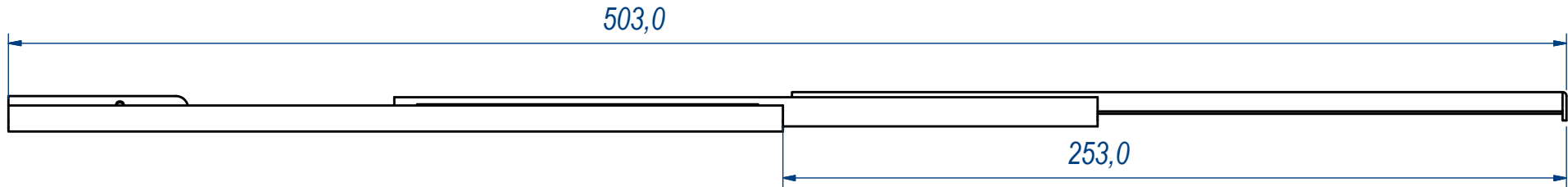
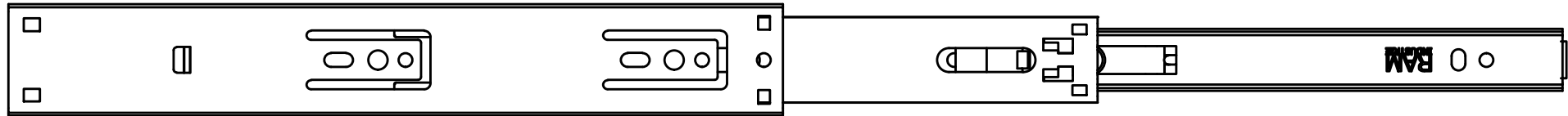

DESIGNED BY F.Dino	CHECKED AND APPROVED BY L. Paleari	REVISION	DATE 26/01/2016	CODE 62250
GENERAL TOLLERANCE SS-ISO-2768-1M			UNIT mm	SHEET 2 of 2
DESCRIPTION			MATERIAL Zinc coated steel	
DEVICE Self closing			PAIR WEIGHT 0,54 Kg	02T

RAM
INDUSTRIE