

B (1:1)

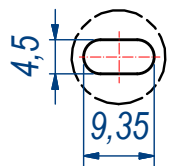

C (1:1)

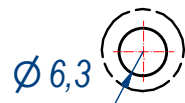

D (1:1)



E (1:1)

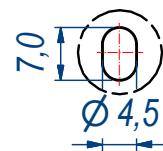

DESIGNED BY F.Dino	CHECKED AND APPROVED BY L. Paleari	REVISION	DATE 26/01/2016	CODE 62300
		GENERAL TOLLERANCE SS-ISO-2768-1M	UNIT mm	SCALE 1 of 2
		DESCRIPTION Self closing	MATERIAL Zinc coated steel	PAIR WEIGHT 0,666 Kg
SHEET 1 of 2 CODE 02T				

Property of RAM Industrie.
Without its written authorization the present drawing shall neither be used for construction anyway, communicated to third parties, nor reproduced.

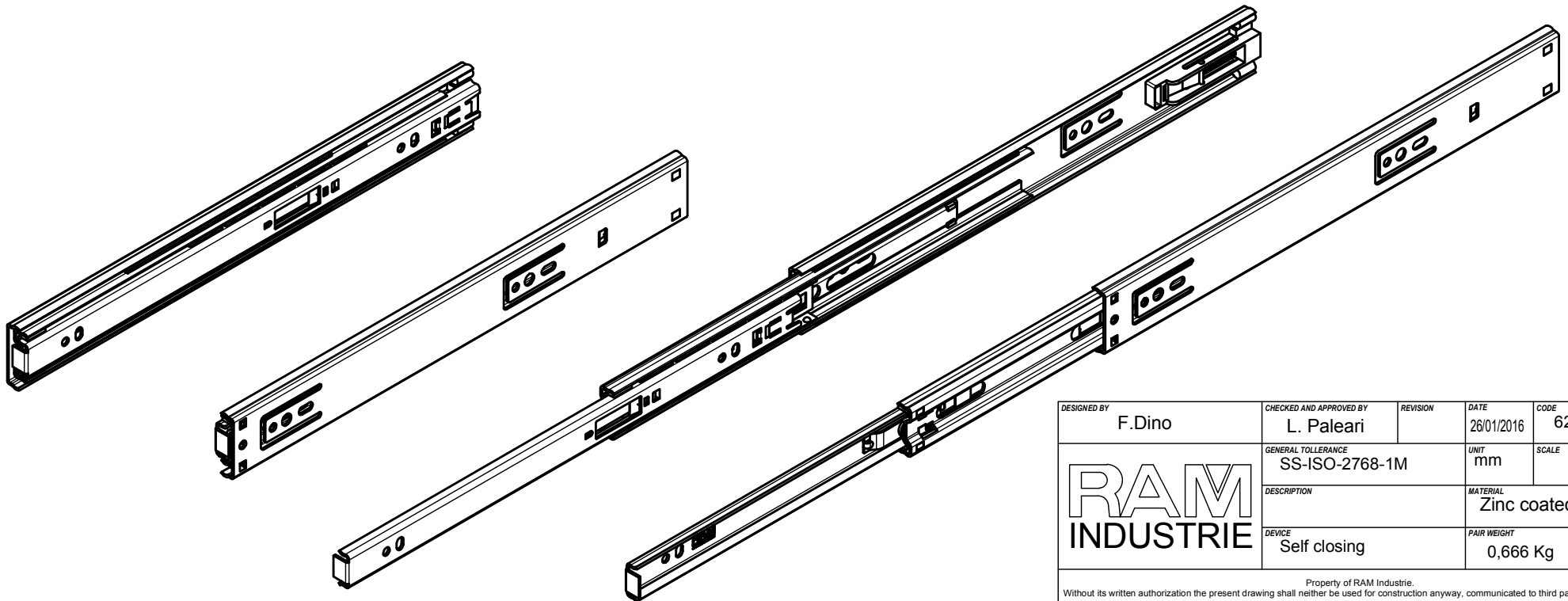
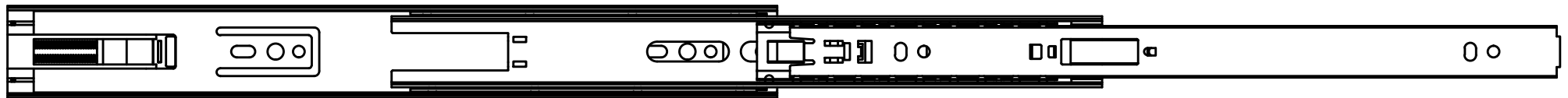
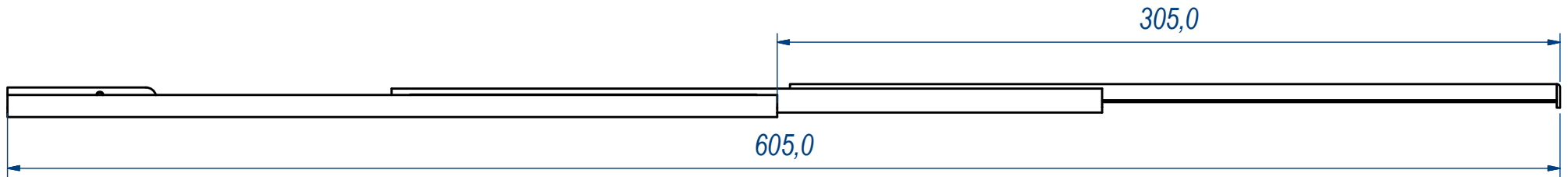
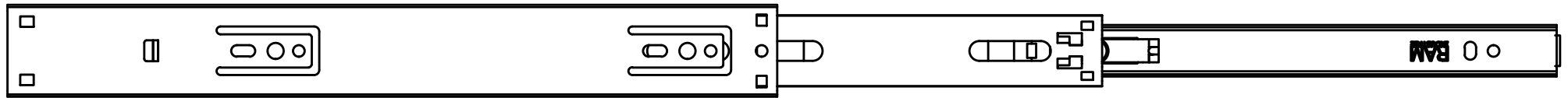

DESIGNED BY F.Dino	CHECKED AND APPROVED BY L. Paleari	REVISION	DATE 26/01/2016	CODE 62300
GENERAL TOLLERANCE SS-ISO-2768-1M			UNIT mm	SCALE SHEET 2 of 2
DESCRIPTION			MATERIAL Zinc coated steel	
DEVICE Self closing			PAIR WEIGHT 0,666 Kg	02T

Property of RAM Industrie.
Without its written authorization the present drawing shall neither be used for construction anyway, communicated to third parties, nor reproduced.