

SEZ. A-A

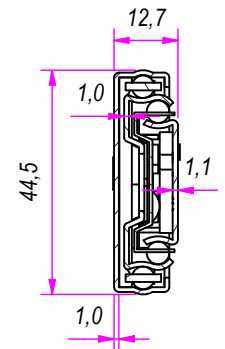

B (1:1)

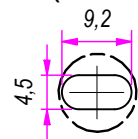

C (1:1)

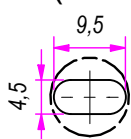

DESIGNED BY F. Dino	CHECKED AND APPROVED BY L. Paleari	GENERAL TOLLERANCE SS-ISO-2768-1M	DATE 30/07/2019	CODE F42250
PACKAGING Carton 15 sets/Packed R+R			UNIT mm	SHEET 1 of 2
DESCRIPTION Soft self closing			MATERIAL Cold rolled steel	PAIR WEIGHT 11C 0,562 Kg

RAM
INDUSTRIE

REVISION HISTORY		REV	DESCRIPTION	DATE
Guide per cassetti; guide telescopiche	Coulisses à billes; coulisse télescopique	1a		30/07/2019
Drawer slide; telescopic ball bearing slide	Guías para cajones; guía teleópica			
Kugelführung; Teleskopschienen				

Property of RAM Industrie.
Without its written authorization the present drawing shall neither be used for construction anyway, communicated to third parties, nor reproduced.

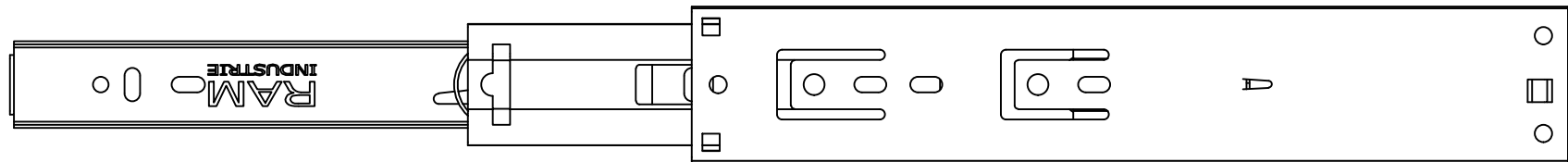

447,0

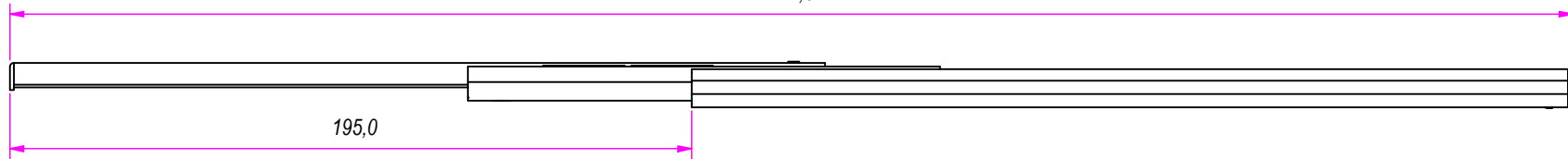

195,0

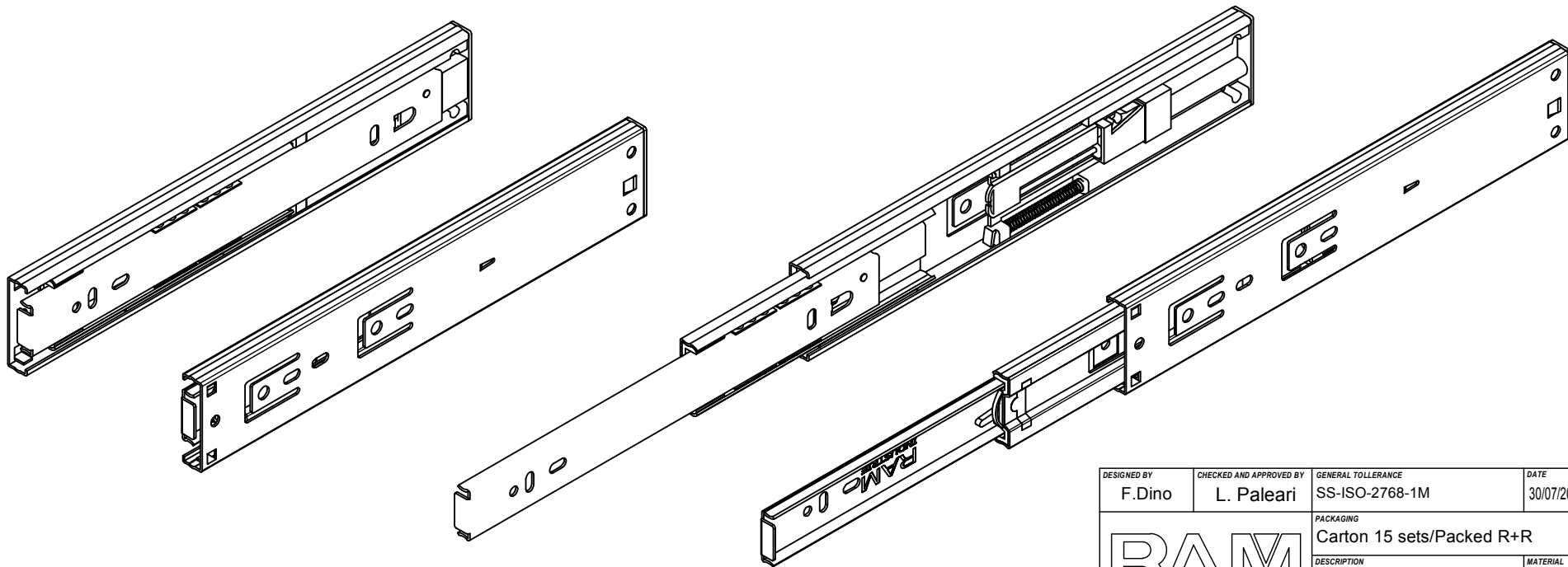
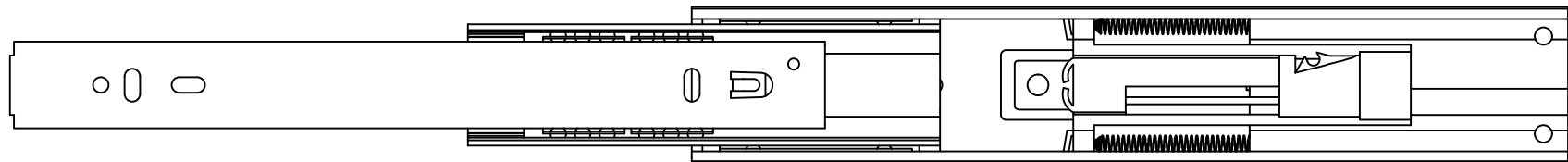

DESIGNED BY F. Dino	CHECKED AND APPROVED BY L. Paleari	GENERAL TOLERANCE SS-ISO-2768-1M	DATE 30/07/2019	CODE F42250
		PACKAGING Carton 15 sets/Packed R+R	UNIT mm	SHEET 2 of 2
		DESCRIPTION Soft self closing	MATERIAL Cold rolled steel	PAIR WEIGHT 11C 0,562 Kg

		REVISION HISTORY		
		REV	DESCRIPTION	DATE
Guide per cassetti; guide telescopiche	Coulisses à billes; coulisse télescopique	1a		30/07/2019
Drawer slide; telescopic ball bearing slide	Guías para cajones; guía teleópica			
Kugelführung; Teleskopschienen				

Property of RAM Industrie.
Without its written authorization the present drawing shall neither be used for construction anyway, communicated to third parties, nor reproduced.