

SEZ. A-A

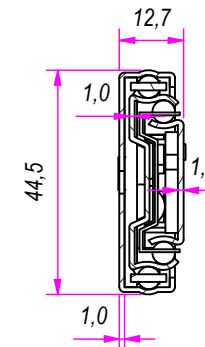

B (1:1)

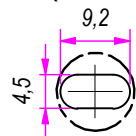

C (1:1)

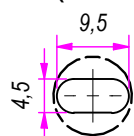

DESIGNED BY F. Dino	CHECKED AND APPROVED BY L. Paleari	GENERAL TOLERANCE SS-ISO-2768-1M	DATE 30/07/2019	CODE F42400
PACKAGING Carton 15 sets/Packed R+R			UNIT mm	SHEET 1 of 2
DESCRIPTION Soft self closing			MATERIAL Cold rolled steel	PAIR WEIGHT 11C 0,936 Kg

RAM
INDUSTRIE

REVISION HISTORY		REV	DESCRIPTION	DATE
Guide per cassetti; guide telescopiche	Coulisses à billes; coulisse télescopique	1a		30/07/2019
Drawer slide; telescopic ball bearing slide	Guías para cajones; guía teleópica			
Kugelführung; Teleskopschienen				

Property of RAM Industrie.
Without its written authorization the present drawing shall neither be used for construction anyway, communicated to third parties, nor reproduced.

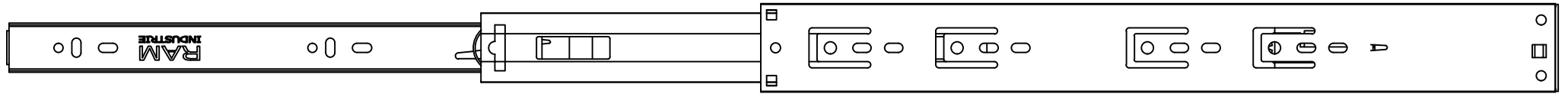

782,0

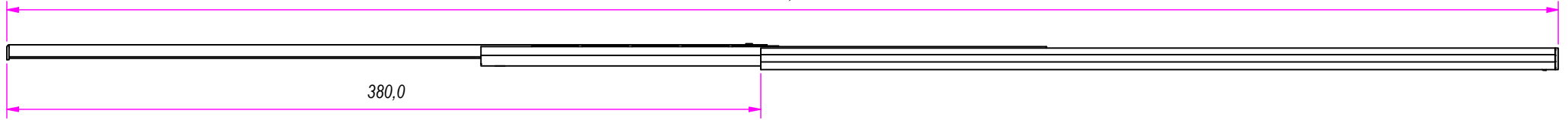

380,0

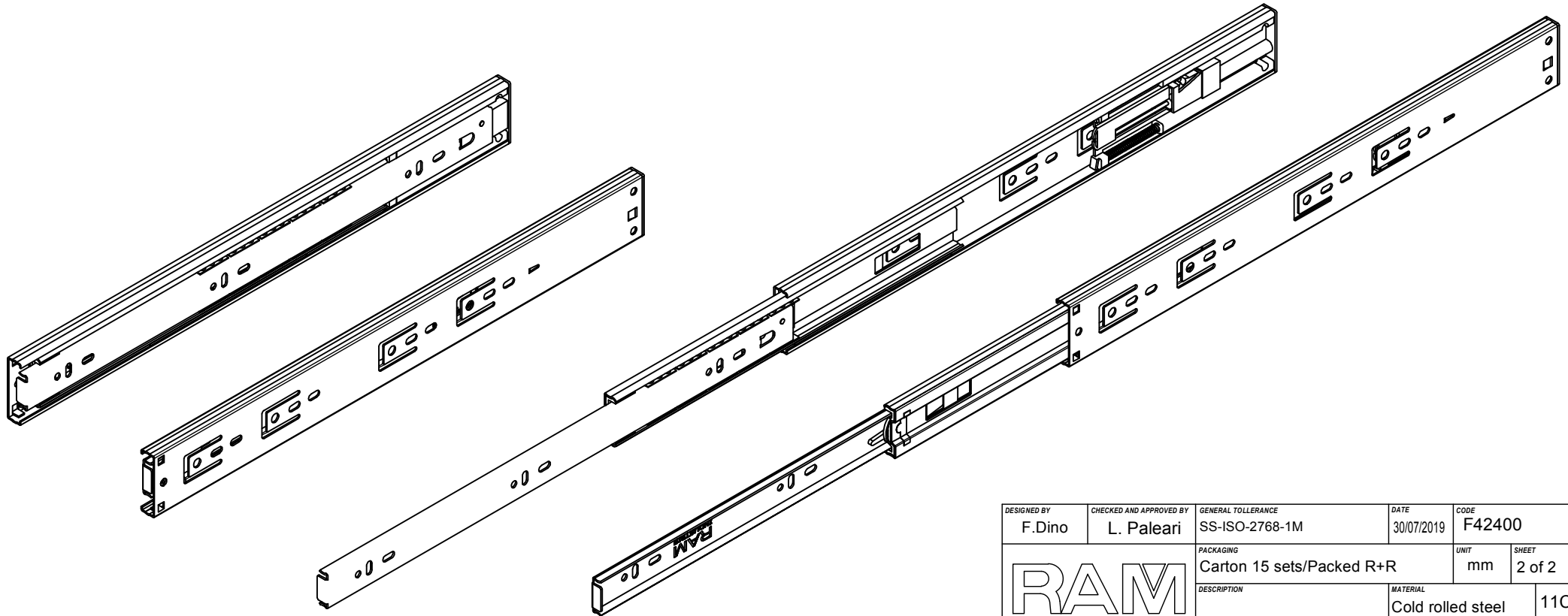
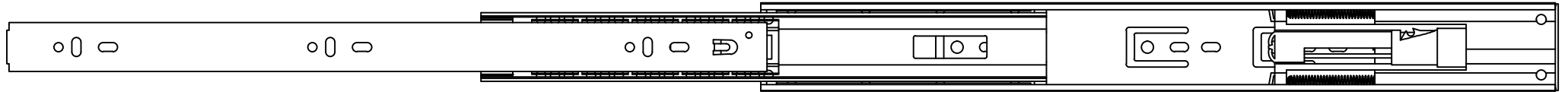

DESIGNED BY F. Dino	CHECKED AND APPROVED BY L. Paleari	GENERAL TOLERANCE SS-ISO-2768-1M	DATE 30/07/2019	CODE F42400
PACKAGING Carton 15 sets/Packed R+R			UNIT mm	SHEET 2 of 2
DESCRIPTION Soft self closing			MATERIAL Cold rolled steel	PAIR WEIGHT 11C 0,936 Kg

RAM
INDUSTRIE

GUIDE PER CASSETTI; GUIDE TELESCOPICHE		COULISSES À BILLES; COULISSE TÉLESCOPIQUE		REVISION HISTORY	
DRAWER SLIDE; TELESCOPIC BALL BEARING SLIDE		GUÍAS PARA CAJONES; GUÍA TELEÓPICA		DESCRIPTION	DATE
Kugelführung; Teleskopschienen				REV 1a	30/07/2019

Property of RAM Industrie.
Without its written authorization the present drawing shall neither be used for construction anyway, communicated to third parties, nor reproduced.