

SEZ. A-A

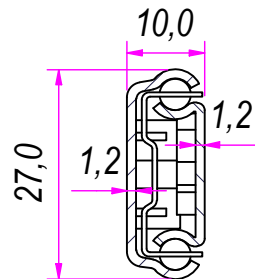

B (1:1)

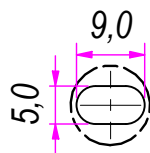

C (1:1)

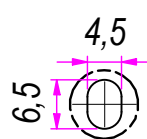

DESIGNED BY F.Dino	CHECKED AND APPROVED BY L. Paleari	REVISION	DATE 11/11/2019	CODE I26350
GENERAL TOLLERANCE SS-ISO-2768-1M		UNIT mm	SCALE	SHEET 1 of 2
DESCRIPTION		MATERIAL Stainless steel AISI 304		
DEVICE		PAIR WEIGHT 0,352 Kg	07C	

Property of RAM Industrie.
Without its written authorization the present drawing shall neither be used for construction anyway, communicated to third parties, nor reproduced.

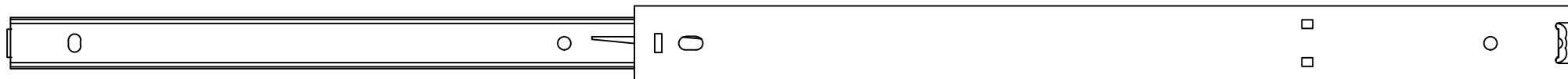

583,0

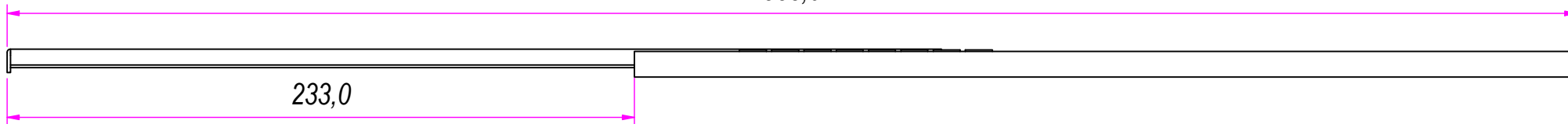

233,0

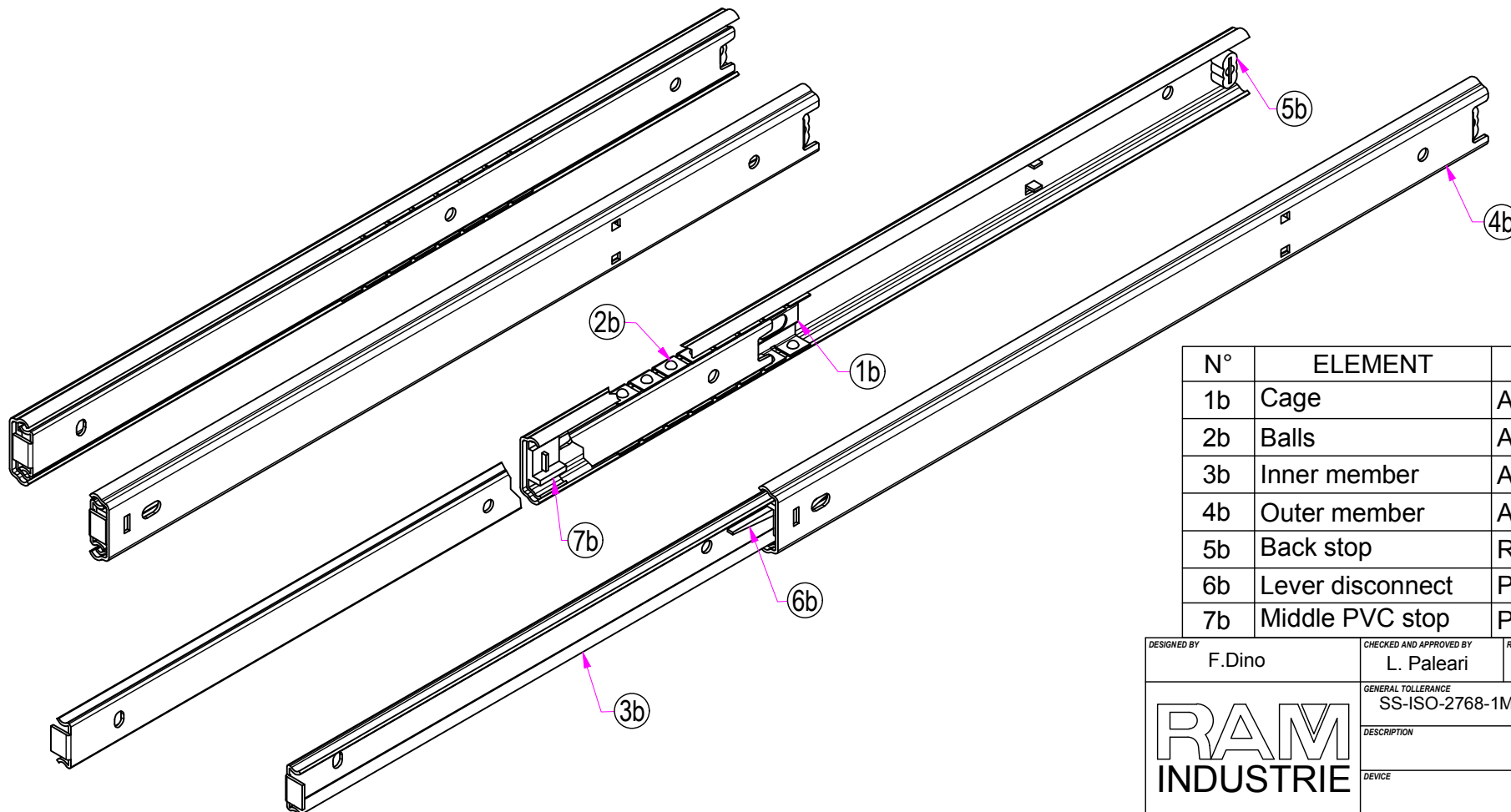
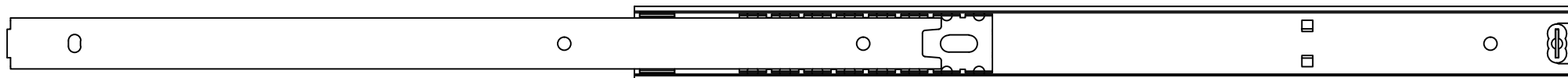

N°	ELEMENT	MATERIAL
1b	Cage	AISI 304 stainless steel
2b	Balls	AISI 304 stainless steel
3b	Inner member	AISI 304 stainless steel
4b	Outer member	AISI 304 stainless steel
5b	Back stop	Rubber
6b	Lever disconnect	PVC
7b	Middle PVC stop	PVC

DESIGNED BY F.Dino	CHECKED AND APPROVED BY L. Paleari	REVISION	DATE 11/11/2019	CODE I26350
GENERAL TOLERANCE SS-ISO-2768-1M		UNIT mm	SCALE	SHEET 2 of 2
DESCRIPTION RAM INDUSTRIE		MATERIAL Stainless steel AISI 304		PAIR WEIGHT 0,434 Kg
DEVICE		07C		

Property of RAM Industrie.
Without its written authorization the present drawing shall neither be used for construction anyway, communicated to third parties, nor reproduced.