

SEZ. A-A

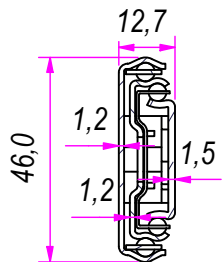

B (1:1)

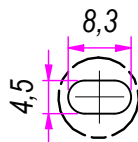

C (1:1)

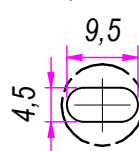

DESIGNED BY F. Dino	CHECKED AND APPROVED BY L. Paleari	GENERAL TOLERANCE SS-ISO-2768-1M	DATE 21/04/2016	CODE I46450
PACKAGING Carton 10 sets/Packed R+R			UNIT mm	SHEET 1 of 2
DESCRIPTION RAM INDUSTRIE			MATERIAL AISI 304 stainless steel	
DEVICE			PAIR WEIGHT 1,312 Kg	01T

Guide per cassetti; guide telescopiche	Coulisses à billes; coulisse télescopique	REVISION HISTORY	
Drawer slide; telescopic ball bearing slide	Guías para cajones; guía teleópica	REV	DESCRIPTION
Kugelführung; Teleskopschienen		1a	DATE 21/04/2016

Property of RAM Industrie.
Without its written authorization the present drawing shall neither be used for construction anyway, communicated to third parties, nor reproduced.

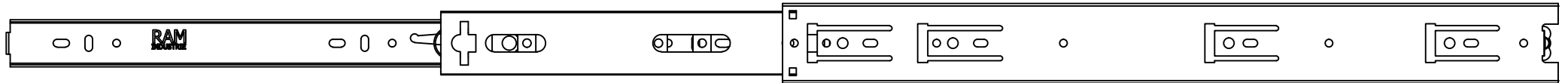

900,0

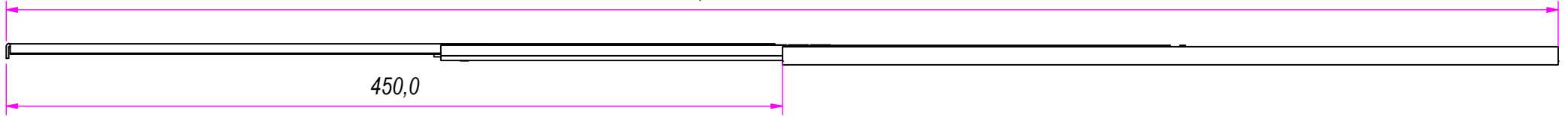

450,0

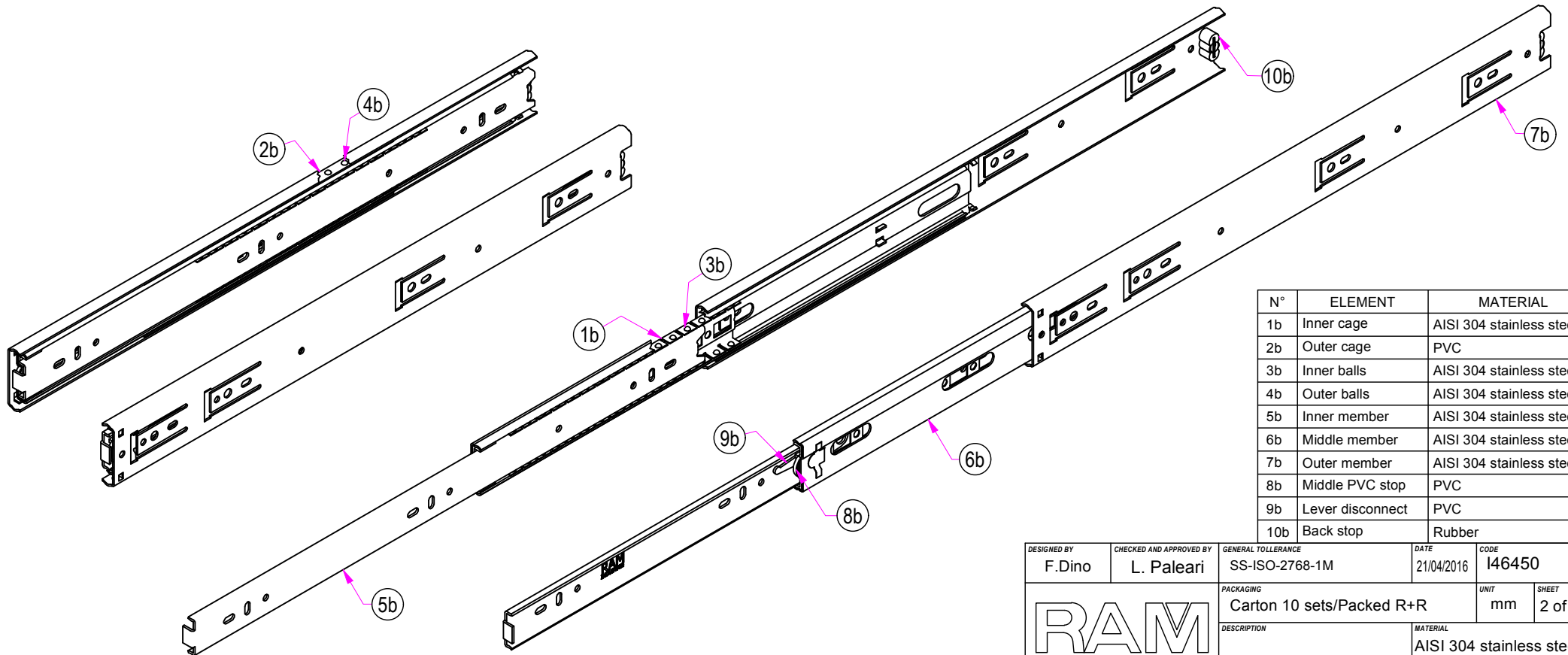
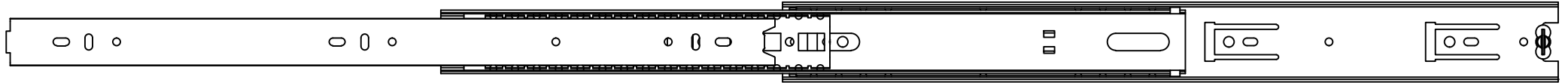

N°	ELEMENT	MATERIAL
1b	Inner cage	AISI 304 stainless steel
2b	Outer cage	PVC
3b	Inner balls	AISI 304 stainless steel
4b	Outer balls	AISI 304 stainless steel
5b	Inner member	AISI 304 stainless steel
6b	Middle member	AISI 304 stainless steel
7b	Outer member	AISI 304 stainless steel
8b	Middle PVC stop	PVC
9b	Lever disconnect	PVC
10b	Back stop	Rubber

DESIGNED BY F. Dino	CHECKED AND APPROVED BY L. Paleari	GENERAL TOLERANCE SS-ISO-2768-1M	DATE 21/04/2016	CODE I46450
		PACKAGING Carton 10 sets/Packed R+R	UNIT mm	SHEET 2 of 2
		DESCRIPTION AISI 304 stainless steel	MATERIAL	
DEVICE		PAIR WEIGHT 1,312 Kg	01T	

GUIDE per cassetti; guide telescopiche		Coulisses à billes; coulisse télescopique		REVISION HISTORY	
Drawer slide; telescopic ball bearing slide		Guías para cajones; guía teleópica		DESCRIPTION	DATE
Kugelführung; Teleskopschienen				REV 1a	21/04/2016

Property of RAM Industrie.
Without its written authorization the present drawing shall neither be used for construction anyway, communicated to third parties, nor reproduced.