

A →

SEZ. A-A

C (1:1)

B (1:1)

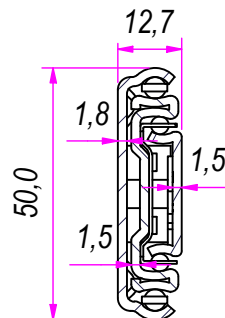
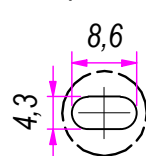
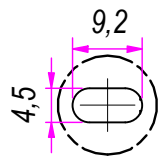

DESIGNED BY F. Dino	CHECKED AND APPROVED BY L. Paleari	GENERAL TOLERANCE SS-ISO-2768-1M	DATE 10/05/2018	CODE LI51400
PACKAGING Carton 10 sets/Packed R+L			UNIT mm	SHEET 1 of 2
DESCRIPTION Lock-in			MATERIAL Cold rolled steel	
			PAIR WEIGHT 1,684 Kg	02C

RAM
INDUSTRIE

GUIDE per cassetti; guide telescopiche		Coulisses à billes; coulisse télescopique		REVISION HISTORY	
Drawer slide; telescopic ball bearing slide		Guías para cajones; guía teleópica		REV	DESCRIPTION
Kugelführung; Teleskopschienen				DATE	
				1a	10/05/2018

Property of RAM Industrie.
Without its written authorization the present drawing shall neither be used for construction anyway, communicated to third parties, nor reproduced.

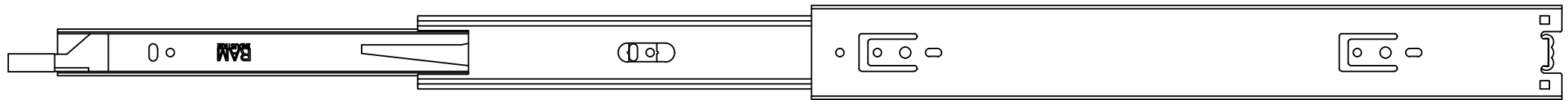

802,0

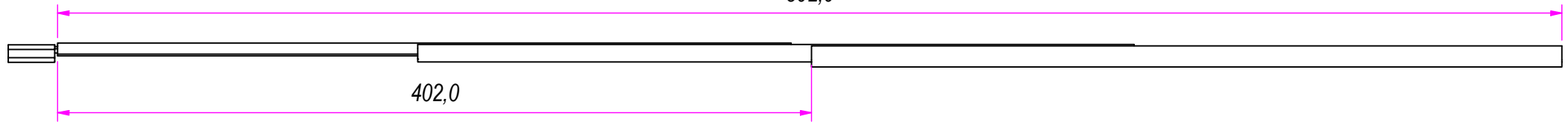

402,0

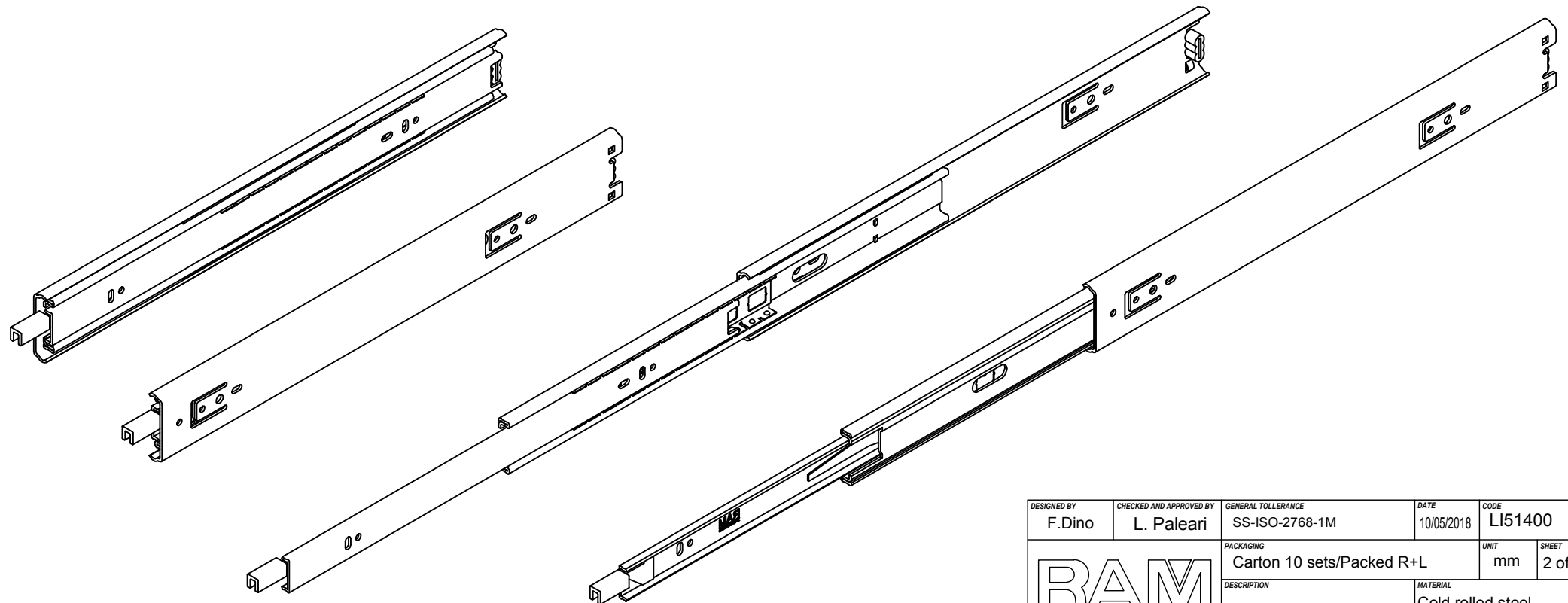
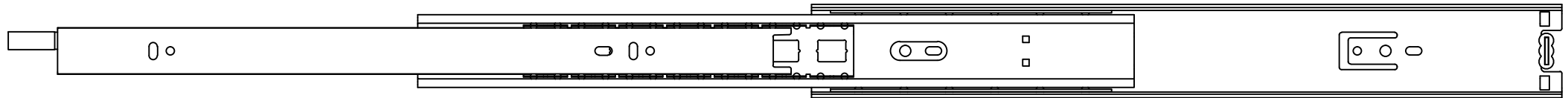

Guide per cassetti; guide telescopiche	Coulisses à billes; coulisse télescopique
Drawer slide; telescopic ball bearing slide	Guías para cajones; guía teleópica
Kugelführung; Teleskopschienen	

REVISION HISTORY	
REV	DESCRIPTION
1a	

DESIGNED BY F. Dino	CHECKED AND APPROVED BY L. Paleari	GENERAL TOLERANCE SS-ISO-2768-1M	DATE 10/05/2018	CODE LI51400
		PACKAGING Carton 10 sets/Packed R+L	UNIT mm	SHEET 2 of 2
		DESCRIPTION Lock-in	MATERIAL Cold rolled steel	PAIR WEIGHT 1,684 Kg
Without its written authorization the present drawing shall neither be used for construction anyway, communicated to third parties, nor reproduced.				