

SEZ. A-A

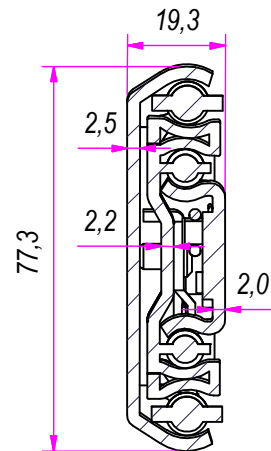

B (1:1)

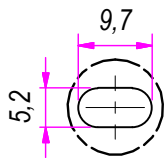

C (1:1)

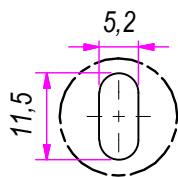

D (1:1)

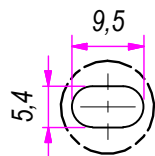

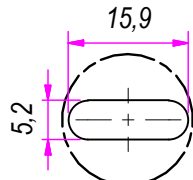

E (1:1)

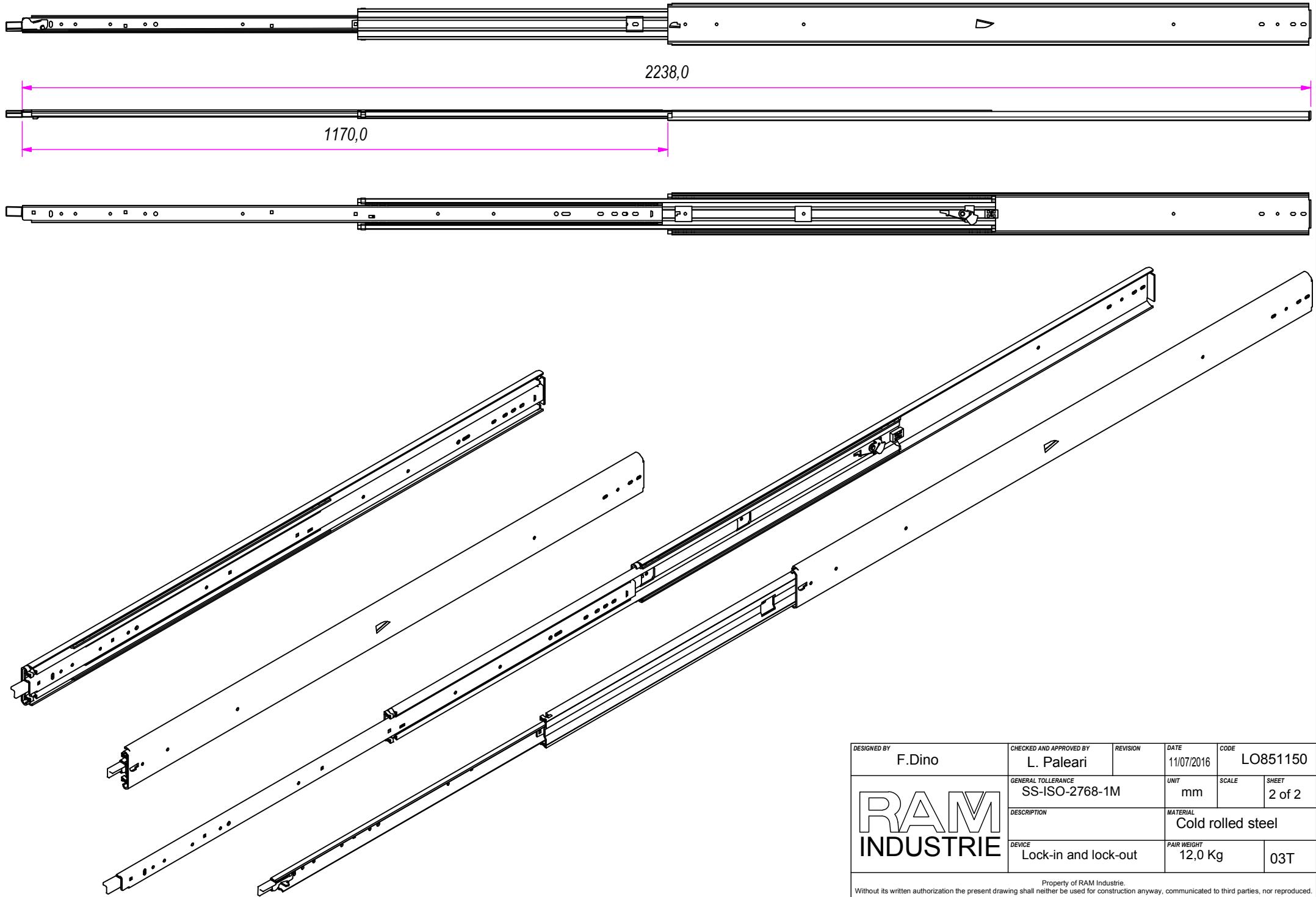

DESIGNED BY F.Dino	CHECKED AND APPROVED BY L. Paleari	REVISION	DATE 11/07/2016	CODE LO851150
GENERAL TOLLERANCE SS-ISO-2768-1M		UNIT mm	SCALE	SHEET 1 of 2
DESCRIPTION Lock-in and lock-out		MATERIAL Cold rolled steel		
PAIR WEIGHT 12,0 Kg		03T		

Property of RAM Industrie.
Without its written authorization the present drawing shall neither be used for construction anyway, communicated to third parties, nor reproduced.



DESIGNED BY F.Dino	CHECKED AND APPROVED BY L. Paleari	REVISION	DATE 11/07/2016	CODE LO851150
GENERAL TOLLERANCE SS-ISO-2768-1M			UNIT mm	SCALE SHEET 2 of 2
			MATERIAL Cold rolled steel	
			DEVICE Lock-in and lock-out	PAIR WEIGHT 12,0 Kg

Property of RAM Industrie.
Without its written authorization the present drawing shall neither be used for construction anyway, communicated to third parties, nor reproduced.