

SEZ. A-A

B (1:1)

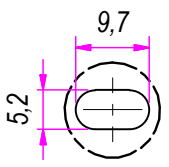

C (1:1)

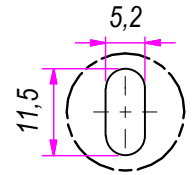

D (1:1)

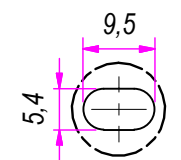

E (1:1)

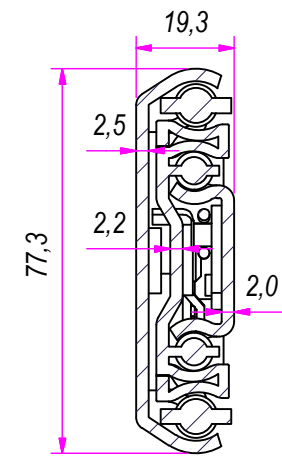
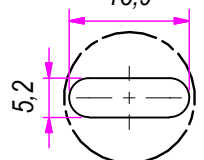

DESIGNED BY F.Dino	CHECKED AND APPROVED BY L. Paleari	REVISION	DATE 11/07/2016	CODE LO85900
RAM INDUSTRIE		GENERAL TOLLERANCE SS-ISO-2768-1M	UNIT mm	SCALE 1 of 2
		DESCRIPTION Lock-in and lock-out	MATERIAL Cold rolled steel	
			PAIR WEIGHT 9,4 Kg	03T
Property of RAM Industrie. Without its written authorization the present drawing shall neither be used for construction anyway, communicated to third parties, nor reproduced.				

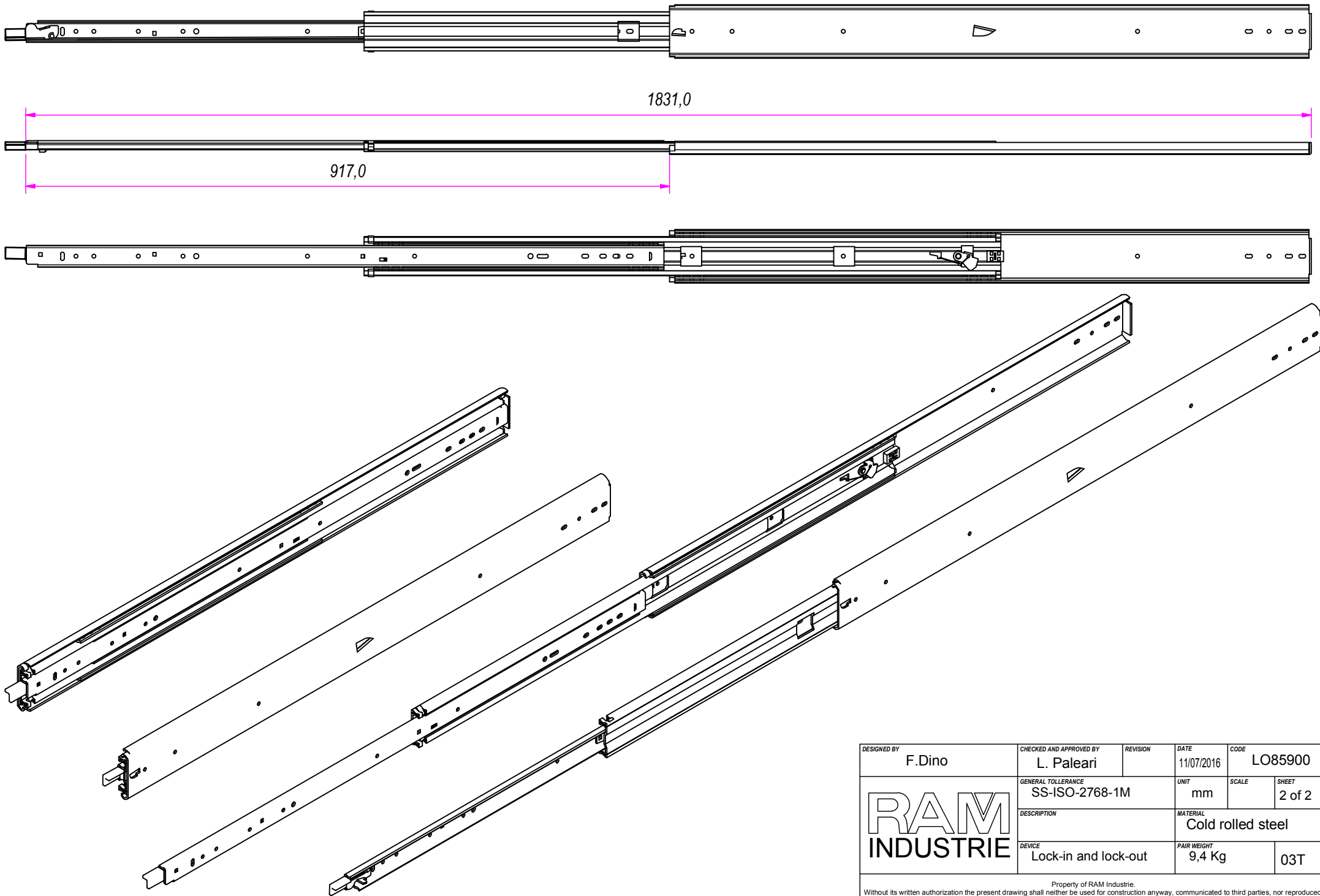

DESIGNED BY F.Dino	CHECKED AND APPROVED BY L. Paleari	REVISION	DATE 11/07/2016	CODE LO85900
GENERAL TOLLERANCE SS-ISO-2768-1M			UNIT mm	SCALE SHEET 2 of 2
			MATERIAL Cold rolled steel	
			DEVICE Lock-in and lock-out	PAIR WEIGHT 9,4 Kg

Property of RAM Industrie.
Without its written authorization the present drawing shall neither be used for construction anyway, communicated to third parties, nor reproduced.