

450,0

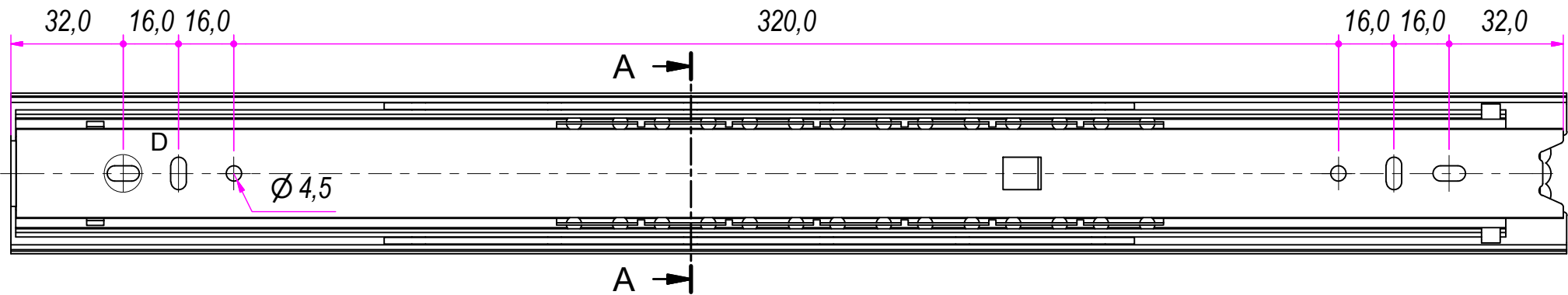

SEZ. A-A

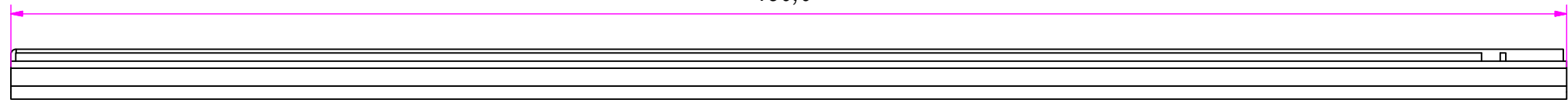
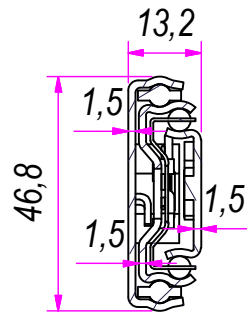

B (1:1)

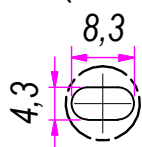

C (1:1)

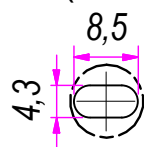

D (1:1)

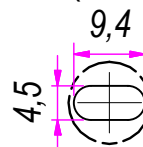

DESIGNED BY F.Dino	CHECKED AND APPROVED BY L. Paleari	REVISION	DATE 30/06/2016	CODE LOS51450
GENERAL TOLERANCE SS-ISO-2768-1M			UNIT mm	SCALE 1 of 2
DESCRIPTION Soft lock-out			MATERIAL Cold rolled steel	
DEVICE			PAIR WEIGHT 1,606 Kg	02C

Property of RAM Industrie.
Without its written authorization the present drawing shall neither be used for construction anyway, communicated to third parties, nor reproduced.

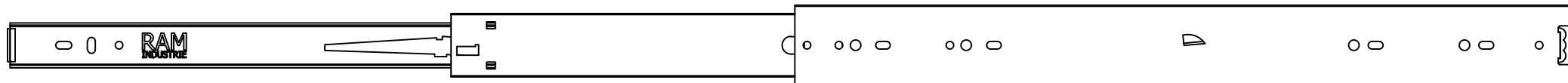

906,0

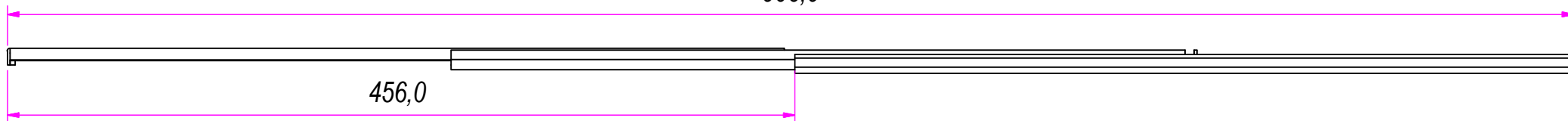

456,0

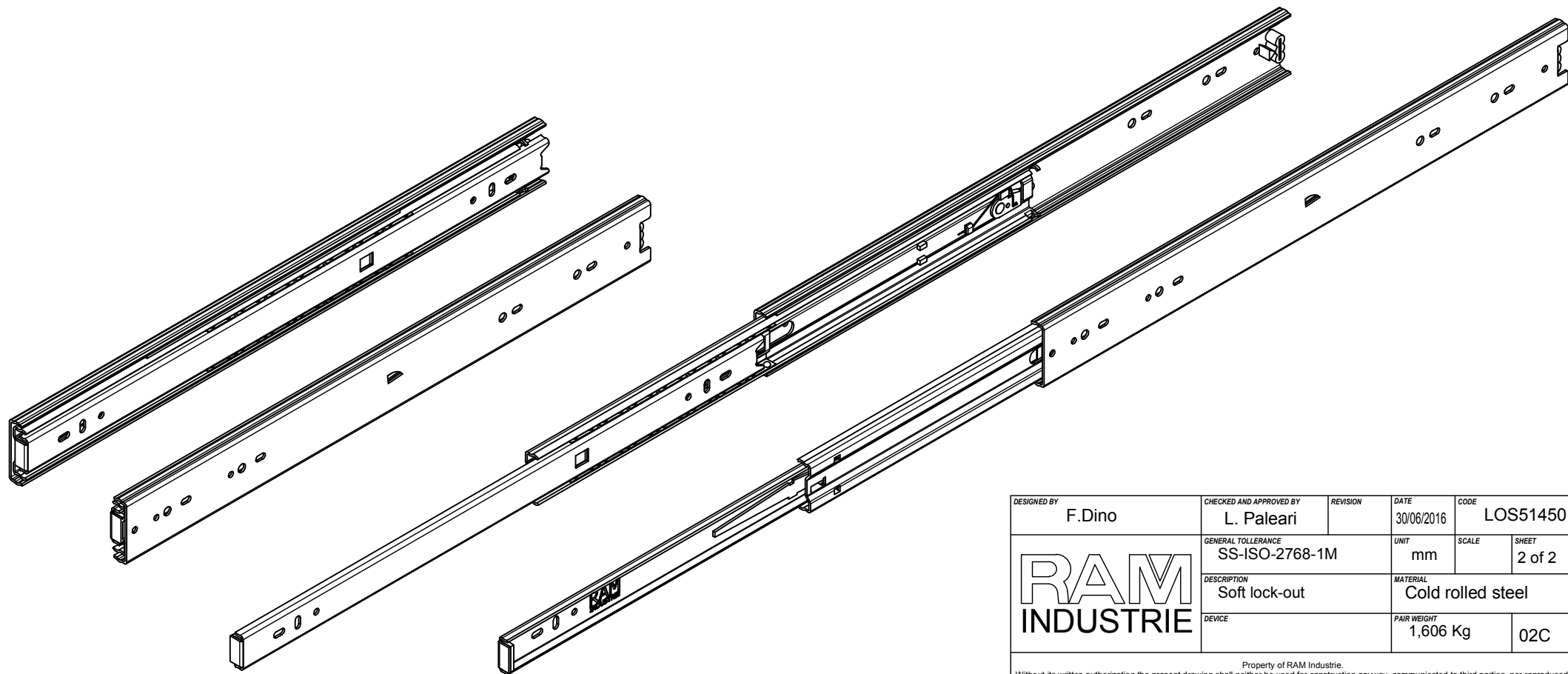
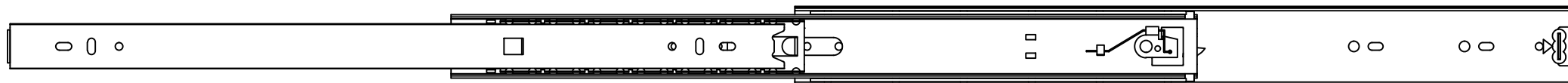

DESIGNED BY F.Dino	CHECKED AND APPROVED BY L. Paleari	REVISION	DATE 30/06/2016	CODE LOS51450
GENERAL TOLLERANCE SS-ISO-2768-1M		UNIT mm	SCALE	SHEET 2 of 2
DESCRIPTION Soft lock-out		MATERIAL Cold rolled steel		
DEVICE		PAIR WEIGHT 1,606 Kg	02C	

Property of RAM Industrie.
Without its written authorization the present drawing shall neither be used for construction anyway, communicated to third parties, nor reproduced.