

SEZ. A-A

B (1:1)

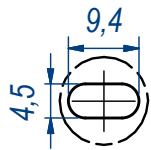

C (1:1)

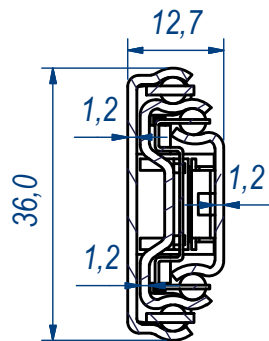
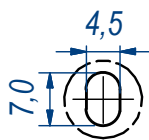

DESIGNED BY F.Dino	CHECKED AND APPROVED BY L. Paleari	REVISION	DATE 14/07/2016	CODE LOS62450
GENERAL TOLLERANCE SS-ISO-2768-1M		UNIT mm	SCALE	SHEET 1 of 2
DESCRIPTION Soft lock-out Self closing with double spring		MATERIAL Zinc coated steel		
		PAIR WEIGHT 1,02 Kg	02T	

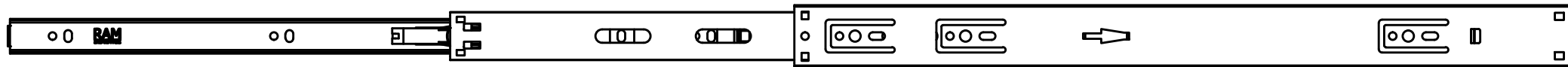

909,0

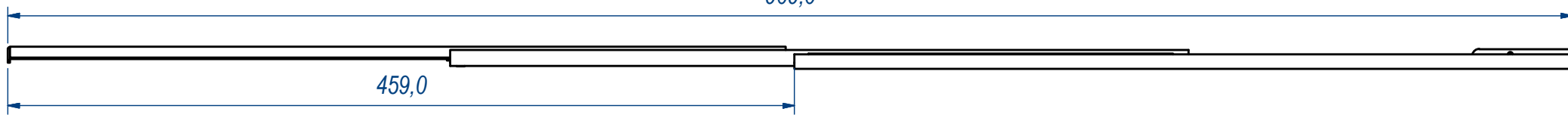

459,0

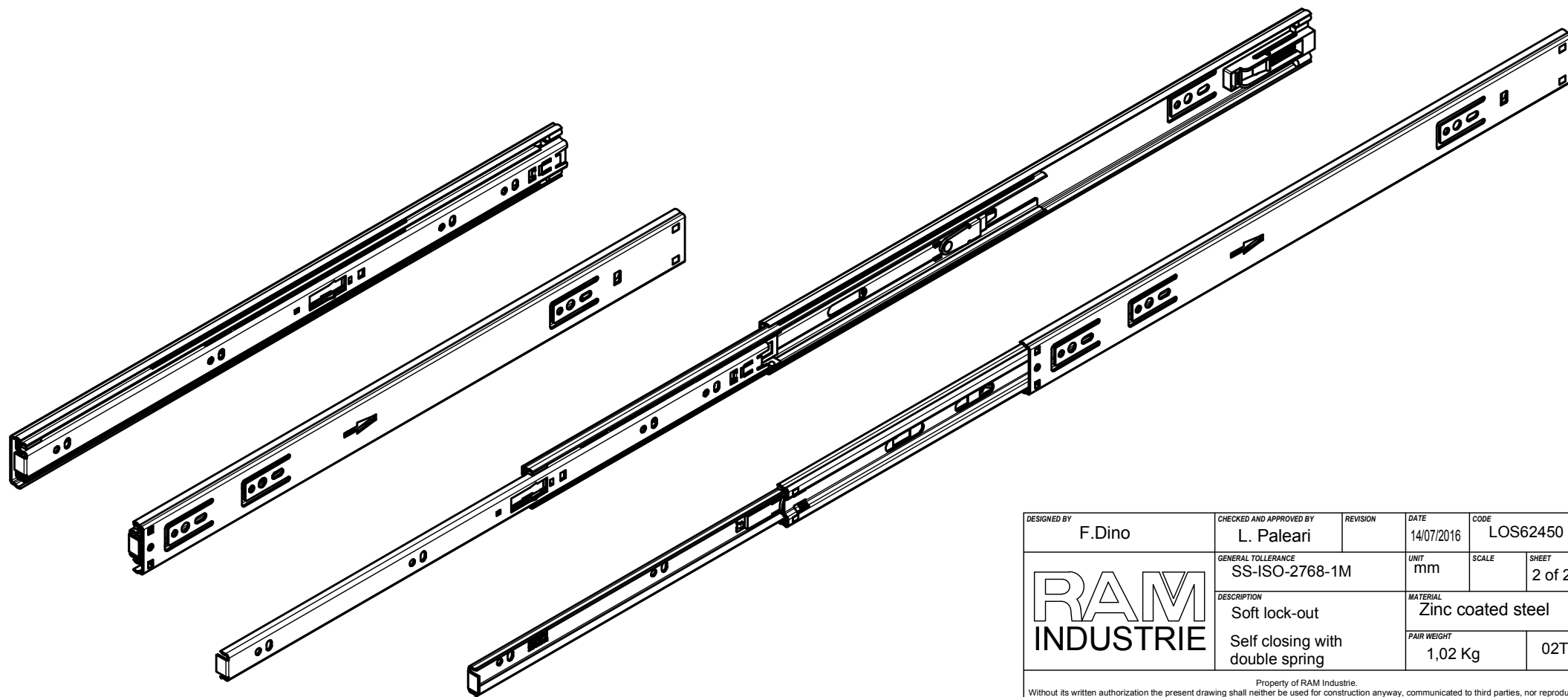

DESIGNED BY F.Dino	CHECKED AND APPROVED BY L. Paleari	REVISION	DATE 14/07/2016	CODE LOS62450
		GENERAL TOLLERANCE SS-ISO-2768-1M	UNIT mm	SCALE 2 of 2
		DESCRIPTION Soft lock-out Self closing with double spring	MATERIAL Zinc coated steel	PAIR WEIGHT 1,02 Kg

Property of RAM Industrie.
Without its written authorization the present drawing shall neither be used for construction anyway, communicated to third parties, nor reproduced.