

SEZ. A-A

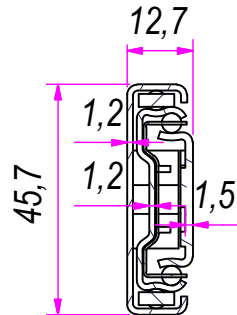

B (1:1)

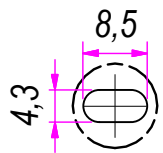

C (1:1)

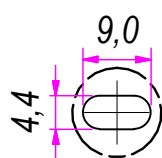

DESIGNED BY F.Dino	CHECKED AND APPROVED BY L. Paleari	REVISION	DATE 30/03/2016	CODE NE44400
GENERAL TOLLERANCE SS-ISO-2768-1M		UNIT mm	SCALE	SHEET 1 of 2
DESCRIPTION Black finishing (cataphoresis coating)		MATERIAL Cold rolled steel		
DEVICE Clip on bracket		PAIR WEIGHT 1,216 Kg	02C	

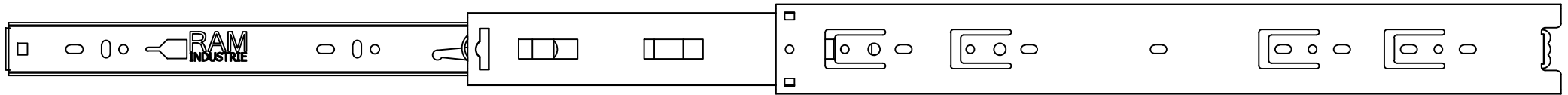

800,0

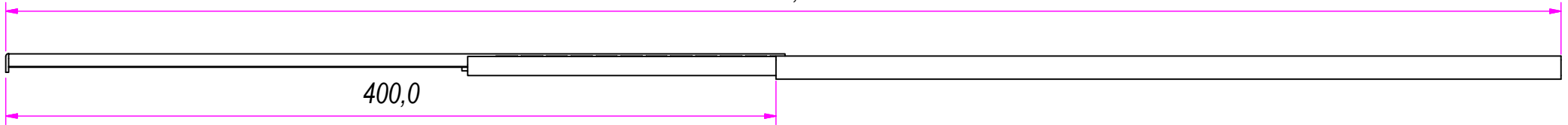

400,0

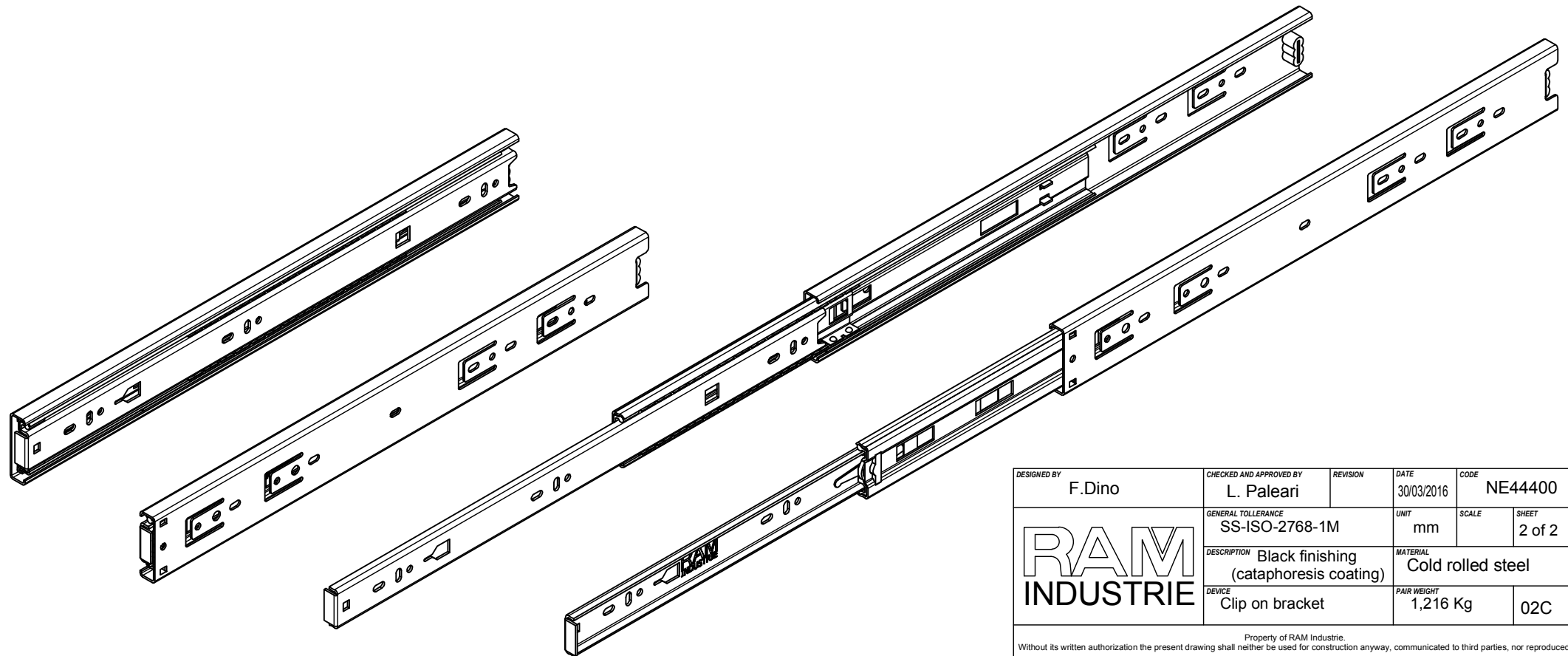
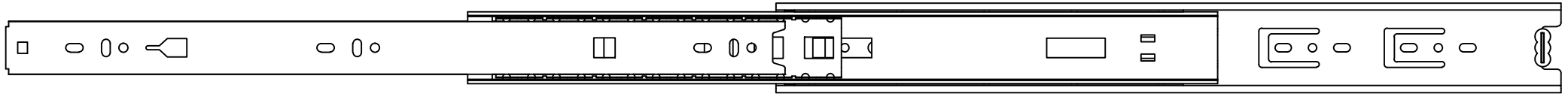

DESIGNED BY F.Dino	CHECKED AND APPROVED BY L. Paleari	REVISION	DATE 30/03/2016	CODE NE44400
		GENERAL TOLLERANCE SS-ISO-2768-1M	UNIT mm	SCALE SHEET 2 of 2
		DESCRIPTION Black finishing (cataphoresis coating)	MATERIAL Cold rolled steel	
DEVICE Clip on bracket	PAIR WEIGHT 1,216 Kg	02C		

Property of RAM Industrie.  
Without its written authorization the present drawing shall neither be used for construction anyway, communicated to third parties, nor reproduced.