

SEZ. A-A

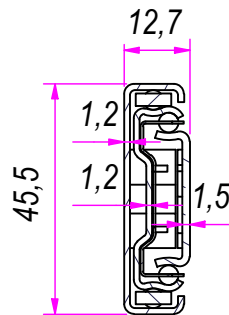

B (1:1)

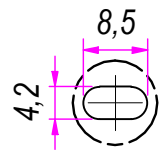

C (1:1)

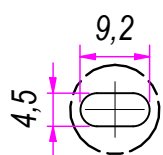

DESIGNED BY F.Dino	CHECKED AND APPROVED BY L. Paleari	REVISION	DATE 15/06/2016	CODE NE48500
GENERAL TOLERANCE SS-ISO-2768-1M			UNIT mm	SCALE 1 of 2
DESCRIPTION Black finishing (cataphoresis coating)			MATERIAL Cold rolled steel	
DEVICE			PAIR WEIGHT 1,486 Kg	02C

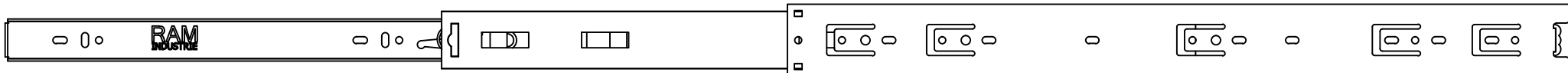

1000,0

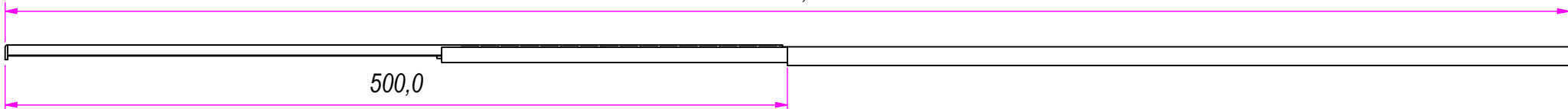

500,0

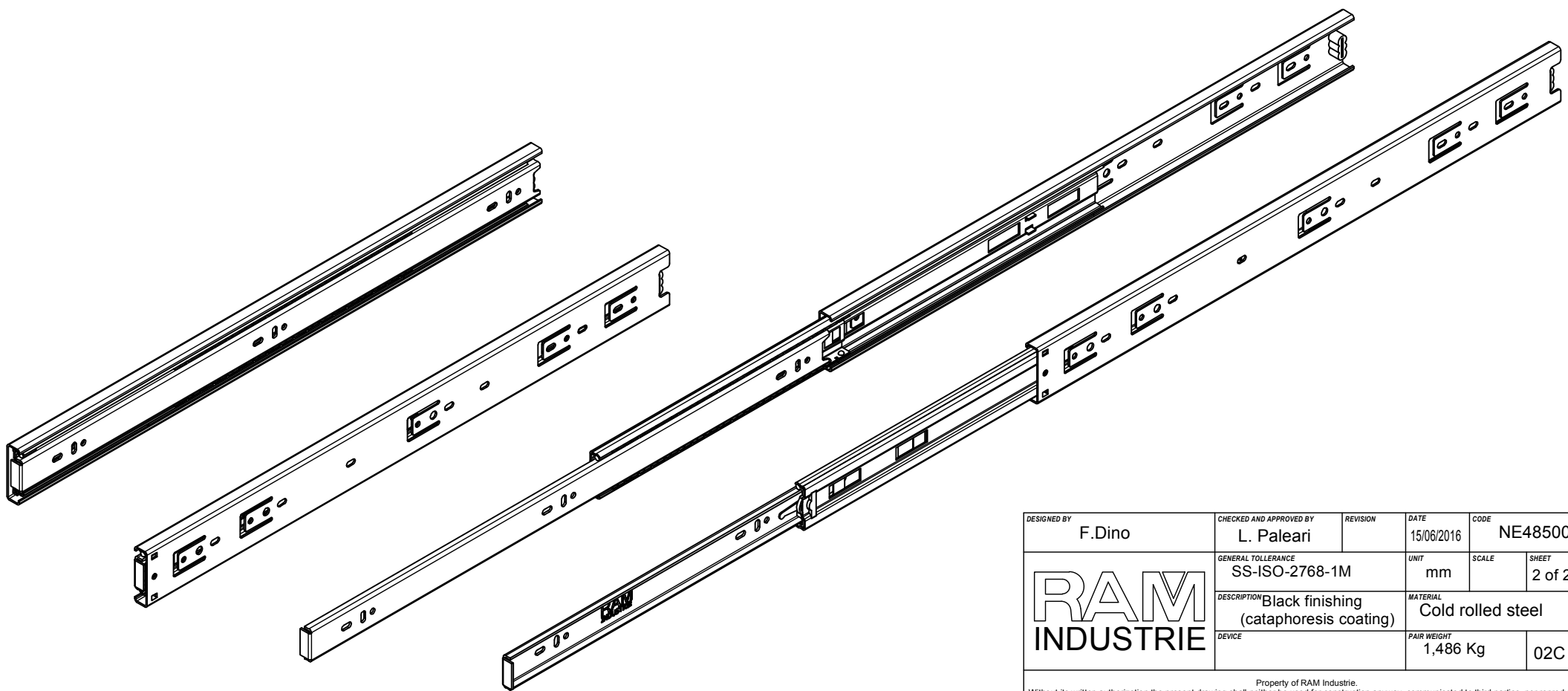
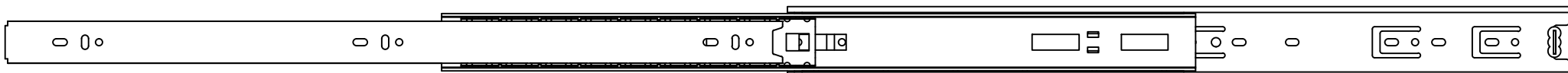

DESIGNED BY F.Dino	CHECKED AND APPROVED BY L. Paleari	REVISION	DATE 15/06/2016	CODE NE48500
		GENERAL TOLLERANCE SS-ISO-2768-1M	UNIT mm	SCALE SHEET 2 of 2
		DESCRIPTION Black finishing (cataphoresis coating)	MATERIAL Cold rolled steel	
DEVICE		PAIR WEIGHT 1,486 Kg	02C	

Property of RAM Industrie.
Without its written authorization the present drawing shall neither be used for construction anyway, communicated to third parties, nor reproduced.