

SEZ. A-A

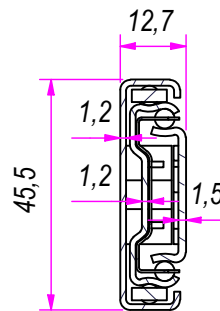

B (1:1)

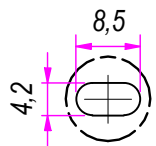

C (1:1)

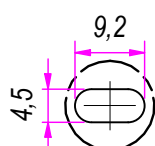

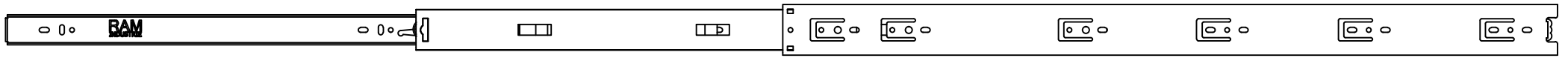

DESIGNED BY F.Dino	CHECKED AND APPROVED BY L. Paleari	REVISION	DATE 15/06/2016	CODE NE48700
GENERAL TOLLERANCE SS-ISO-2768-1M			UNIT mm	SCALE 1 of 2
DESCRIPTION Black finishing (cataphoresis coating)			MATERIAL Cold rolled steel	
DEVICE			PAIR WEIGHT 2,172 Kg	02C

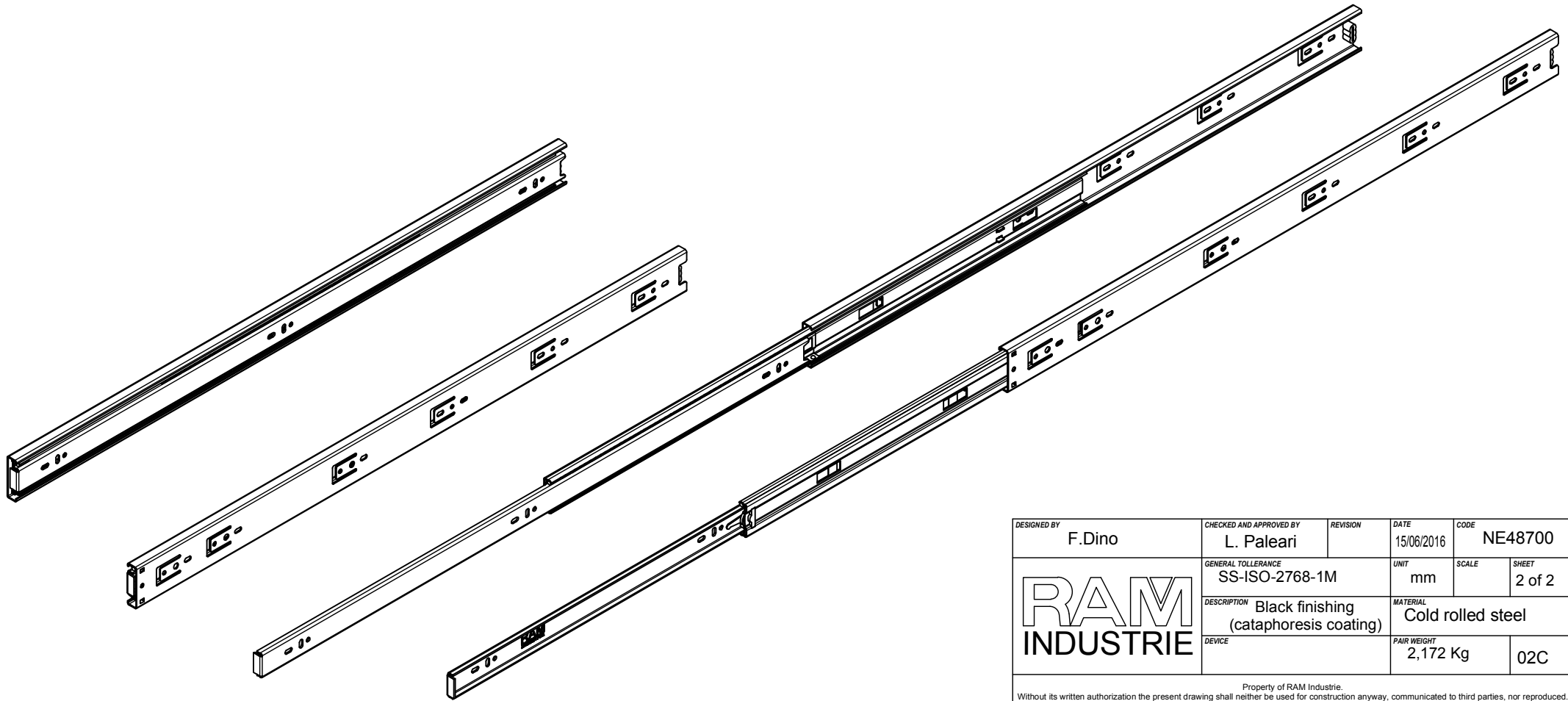
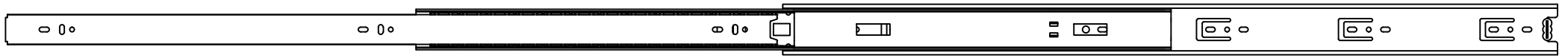

1400,0

700,0



DESIGNED BY F.Dino	CHECKED AND APPROVED BY L. Paleari	REVISION	DATE 15/06/2016	CODE NE48700
		GENERAL TOLLERANCE SS-ISO-2768-1M	UNIT mm	SHEET 2 of 2
		DESCRIPTION Black finishing (cataphoresis coating)	MATERIAL Cold rolled steel	
DEVICE			PAIR WEIGHT 2,172 Kg	02C

Property of RAM Industrie.
Without its written authorization the present drawing shall neither be used for construction anyway, communicated to third parties, nor reproduced.