

450,0

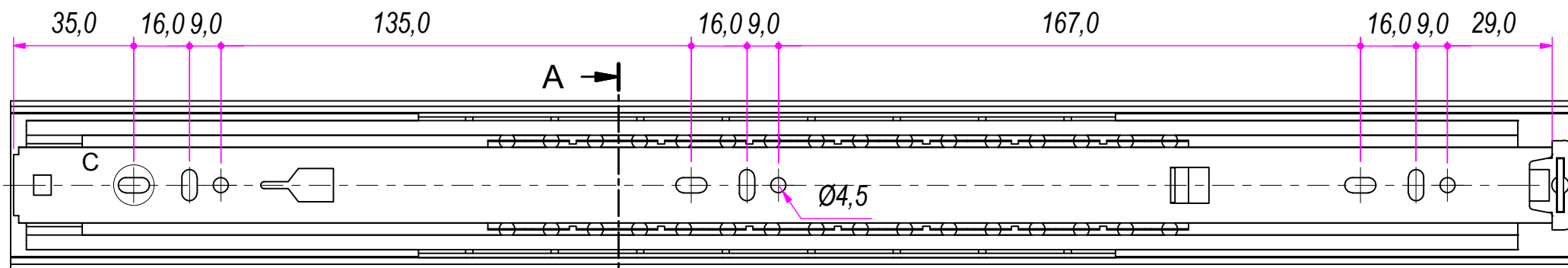

A

A

SEZ. A-A

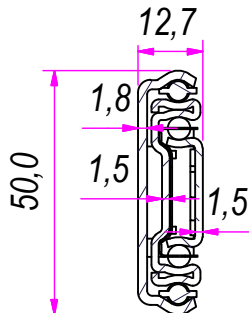
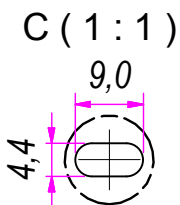
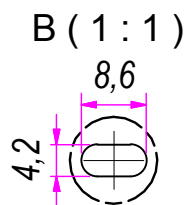

DESIGNED BY F.Dino	CHECKED AND APPROVED BY L. Paleari	REVISION	DATE 10/06/2016	CODE NE51450
GENERAL TOLLERANCE SS-ISO-2768-1M			UNIT mm	SCALE SHEET 1 of 2
DESCRIPTION Black finishing (cataphoresis coating)			MATERIAL Cold rolled steel	
DEVICE Clip on bracket			PAIR WEIGHT 1,832 Kg	02C

Property of RAM Industrie.  
Without its written authorization the present drawing shall neither be used for construction anyway, communicated to third parties, nor reproduced.

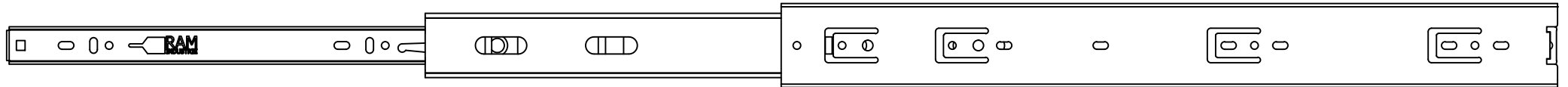

897,0

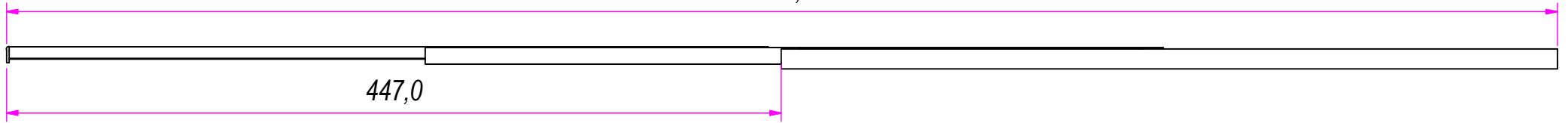

447,0

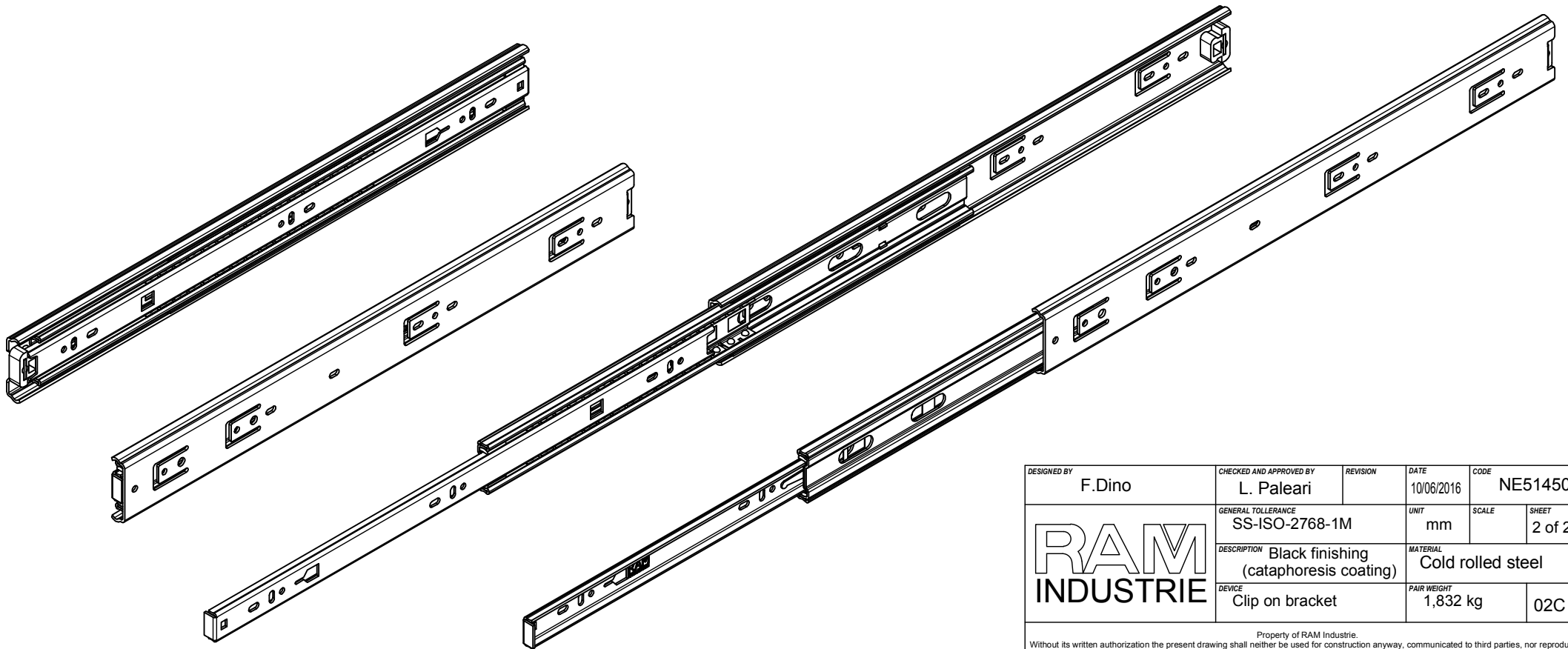
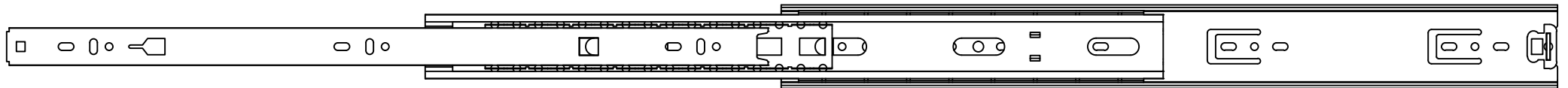

DESIGNED BY F.Dino	CHECKED AND APPROVED BY L. Paleari	REVISION	DATE 10/06/2016	CODE NE51450
GENERAL TOLLERANCE SS-ISO-2768-1M		UNIT mm	SCALE	SHEET 2 of 2
DESCRIPTION Black finishing (cataphoresis coating)		MATERIAL Cold rolled steel		
DEVICE Clip on bracket		PAIR WEIGHT 1,832 kg	02C	

Property of RAM Industrie.  
Without its written authorization the present drawing shall neither be used for construction anyway, communicated to third parties, nor reproduced.