

SEZ. A-A

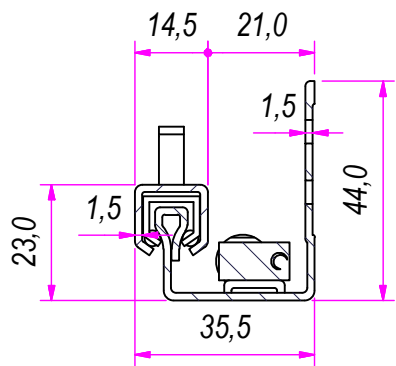

Guide per cassetti; guide telescopiche	Coulisses à billes; coulisse télescopique
Drawer slide; telescopic ball bearing slide	Guías para cajones; guía teleópica
Kugelführung; Teleskopschienen	

REVISION HISTORY	
REV	DESCRIPTION
1a	

DESIGNED BY F. Dino	CHECKED AND APPROVED BY L. Paleari	GENERAL TOLLERANCE SS-ISO-2768-1M	DATE 07/03/2017	CODE Q16500
		PACKAGING Carton 10 sets/Packed R+L	UNIT mm	SHEET 1 of 3
		DESCRIPTION Single extension	MATERIAL Cold rolled steel	
		DEVICE Soft self closing	PAIR WEIGHT 1,29 Kg	09C
Property of RAM Industrie.				
Without its written authorization the present drawing shall neither be used for construction anyway, communicated to third parties, nor reproduced.				

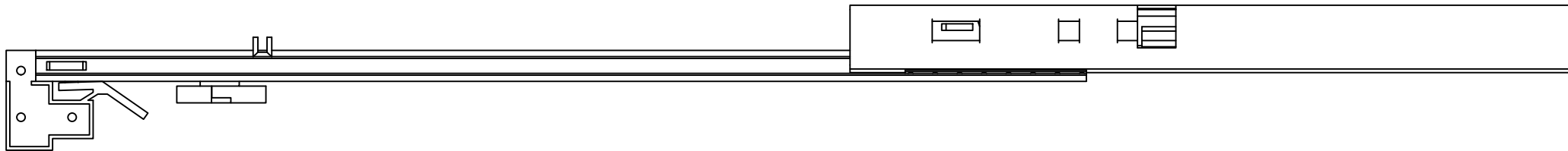

737,0

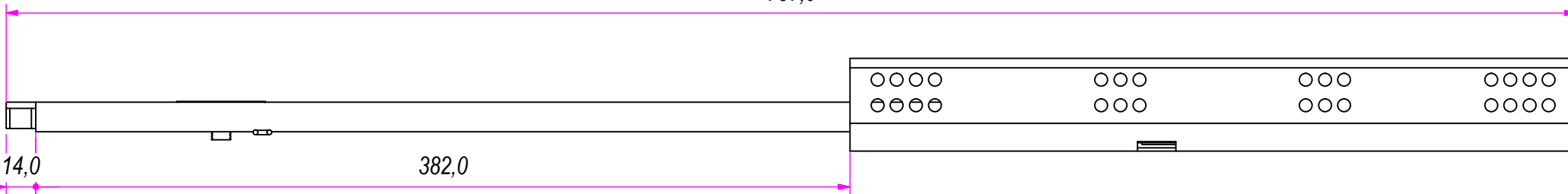

14,0

382,0

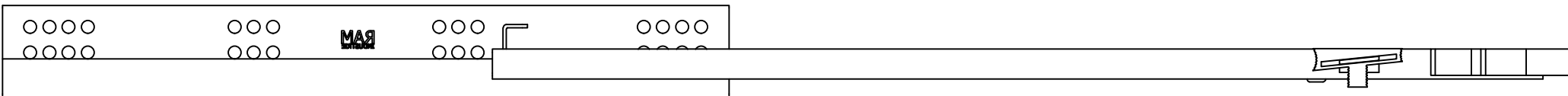
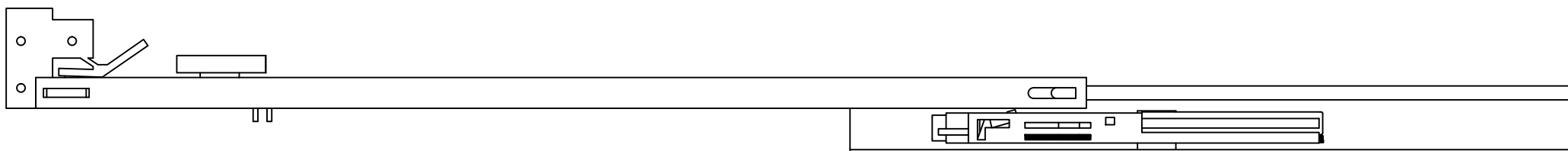

Guida per cassetti; guide telescopiche	Coulisses à billes; coulisse télescopique	REVISION HISTORY		
Drawer slide; telescopic ball bearing slide	Guías para cajones; guía teleópica	REV	DESCRIPTION	DATE
Kugelführung; Teleskopschienen		1a		07/03/2017

DESIGNED BY F. Dino	CHECKED AND APPROVED BY L. Paleari	GENERAL TOLERANCE SS-ISO-2768-1M	DATE 07/03/2017	CODE Q16500
PACKAGING Carton 10/Packed R+L			UNIT mm	SHEET 2 of 3
DESCRIPTION Single extension			MATERIAL Cold rolled steel	
DEVICE Soft self closing			PAIR WEIGHT 1,29 Kg	09C
				
<small>Property of RAM Industrie. Without its written authorization the present drawing shall neither be used for construction anyway, communicated to third parties, nor reproduced.</small>				

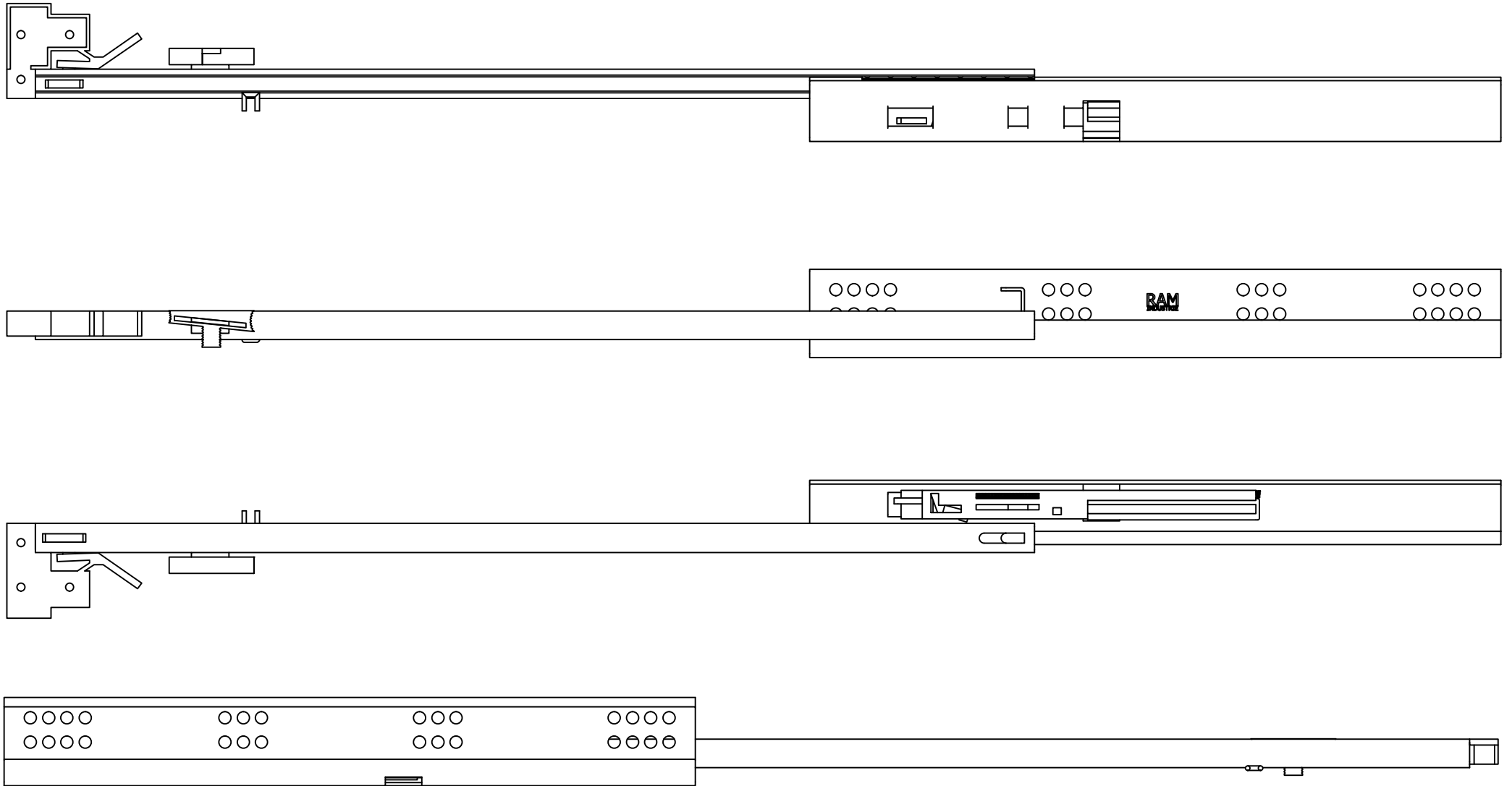

DESIGNED BY F.Dino	CHECKED AND APPROVED BY L. Paleari	GENERAL TOLERANCE SS-ISO-2768-1M	DATE 07/03/2017	CODE Q16500
		PACKAGING Carton 10/Packed R+L	UNIT mm	SHEET 3 of 3
		DESCRIPTION Single extension	MATERIAL Cold rolled steel	
		DEVICE Soft self closing	PAIR WEIGHT 1,29 Kg	09C
<small>Property of RAM Industrie. Without its written authorization the present drawing shall neither be used for construction anyway, communicated to third parties, nor reproduced.</small>				