

B (1:1.5)

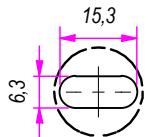

C (1:1.5)

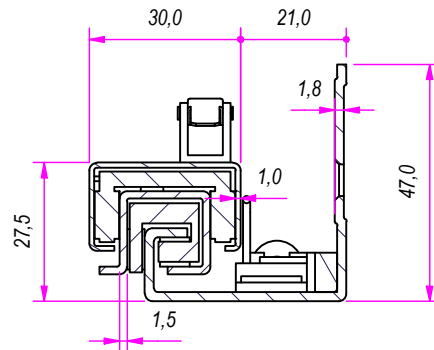
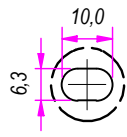

Guide per cassetti; guide telescopiche	Coulisses à billes; coulisse télescopique
Drawer slide; telescopic ball bearing slide	Guías para cajones; guía teleópica
Kugelführung; Teleskopschienen	

REVISION HISTORY	
REV	DESCRIPTION
1a	

DESIGNED BY F.Dino	CHECKED AND APPROVED BY L. Paleari	GENERAL TOLERANCE SS-ISO-2768-1M	DATE 10/06/2019	CODE Q21600
		PACKAGING Carton 10 sets/Packed R+L	UNIT mm	SHEET 1 of 3
		DESCRIPTION Soft self closing/Oil piston	MATERIAL Cold rolled steel	04C
		PAIR WEIGHT 2,554 Kg	PAIR WEIGHT WITH CARTON 2,696 Kg	
Property of RAM Industrie. Without its written authorization the present drawing shall neither be used for construction anyway, communicated to third parties, nor reproduced.				

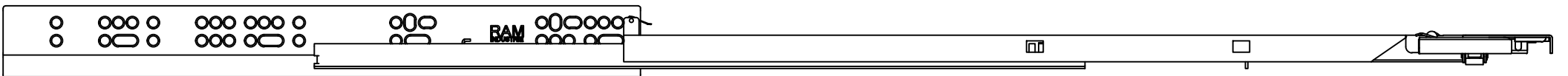
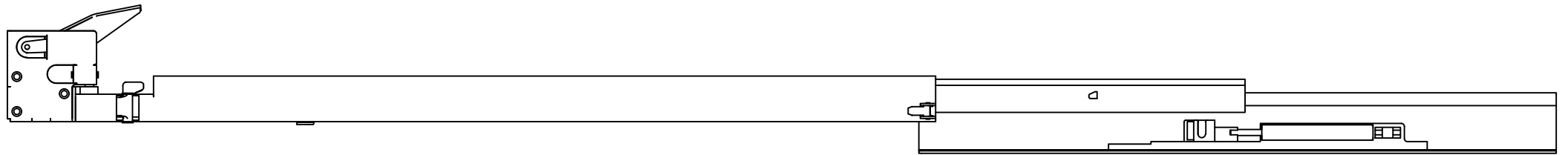
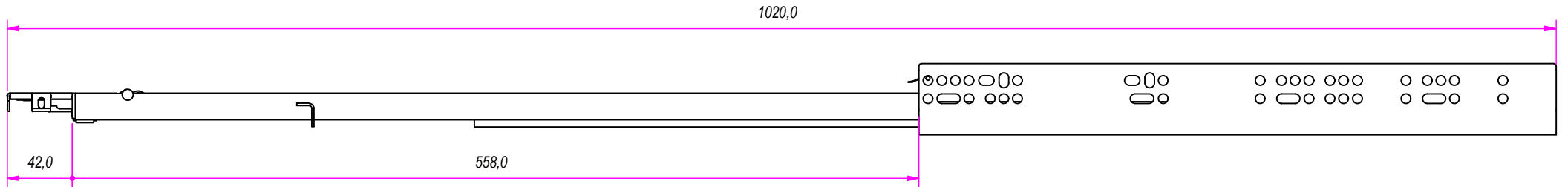
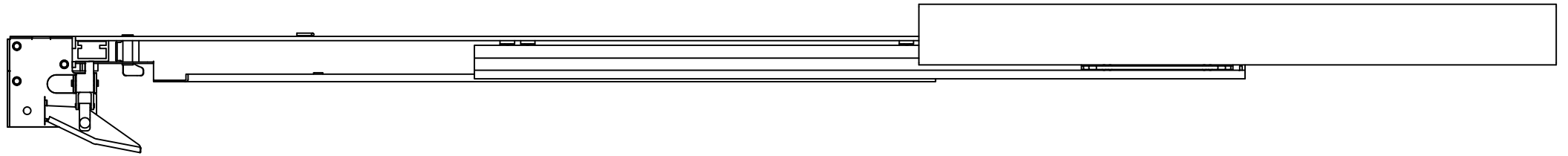

GUIDE PER CASSETTI; GUIDE TELESCOPICHE	COULISSES À BILLES; COULISSE TÉLESCOPIQUE	REVISION HISTORY	
DRAWER SLIDE; TELESCOPIC BALL BEARING SLIDE	GUÍAS PARA CAJONES; GUÍA TELEÓPICA	REV	DESCRIPTION
Kugelführung; Teleskopschienen		1a	

DESIGNED BY F. Dino	CHECKED AND APPROVED BY L. Paleari	GENERAL TOLERANCE SS-ISO-2768-1M	DATE 10/06/2019	CODE Q21600
		PACKAGING Carton 10 sets/Packed R+L	UNIT mm	SHEET 2 of 3
		DESCRIPTION Soft self closing/Oil piston	MATERIAL Cold rolled steel	04C
		PAIR WEIGHT 2,554 Kg	PAIR WEIGHT WITH CARTON 2,696 Kg	
Property of RAM Industrie.				
Without its written authorization the present drawing shall neither be used for construction anyway, communicated to third parties, nor reproduced.				

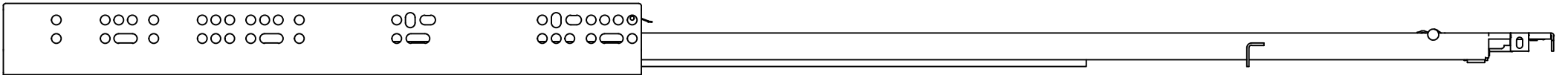
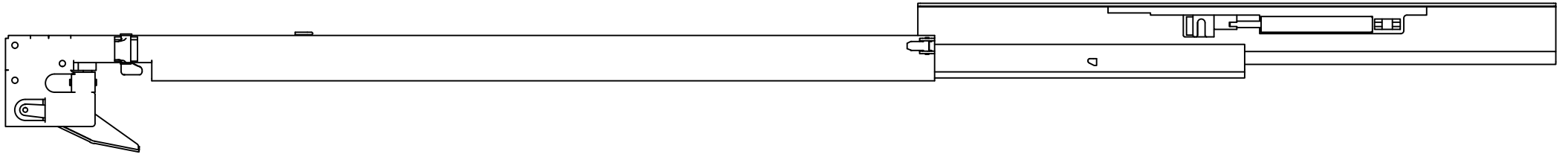
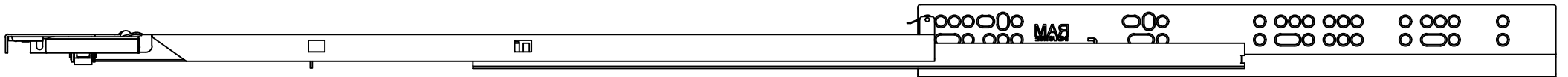
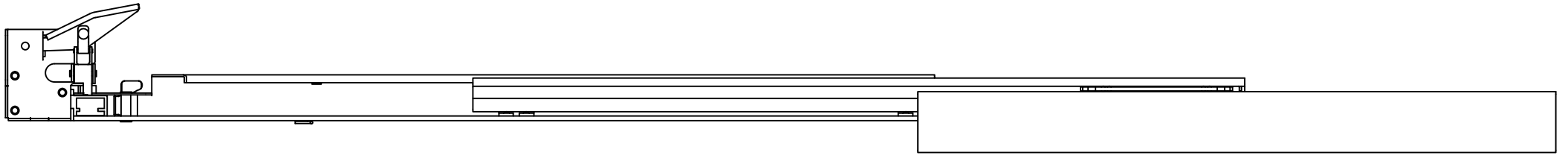

DESIGNED BY F.Dino	CHECKED AND APPROVED BY L. Paleari	GENERAL TOLLERANCE SS-ISO-2768-1M	DATE 10/06/2019	CODE Q21600
		PACKAGING Carton 10 sets/Packed R+L	UNIT mm	SHEET 3 of 3
		DESCRIPTION Soft self closing/Oil piston	MATERIAL Cold rolled steel	04C
		PAIR WEIGHT 2,554 Kg	PAIR WEIGHT WITH CARTON 2,696 Kg	

Property of RAM Industrie.  
Without its written authorization the present drawing shall neither be used for construction anyway, communicated to third parties, nor reproduced.