

SEZ. A-A

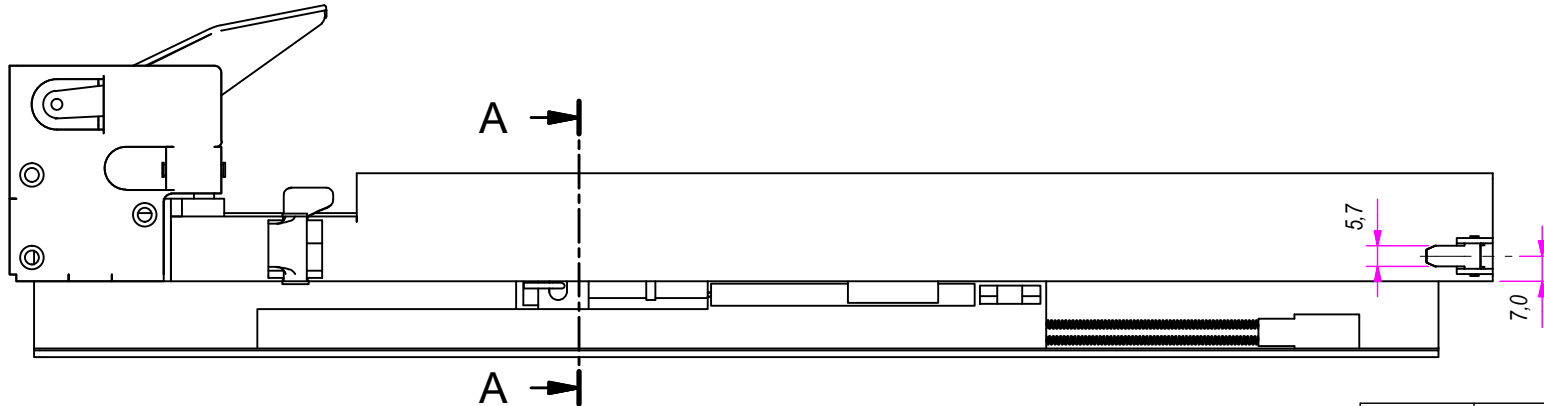

DESIGNED BY F. Dino	CHECKED AND APPROVED BY L. Paleari	GENERAL TOLERANCE SS-ISO-2768-1M	DATE 05/04/2017	CODE Q23400
PACKAGING Carton 10 sets/Packed R+L			UNIT mm	SHEET 1 of 3
DESCRIPTION Soft self closing/Oil piston/ Push&Rebound			MATERIAL Cold rolled steel	
			PAIR WEIGHT 2,06 Kg	04C

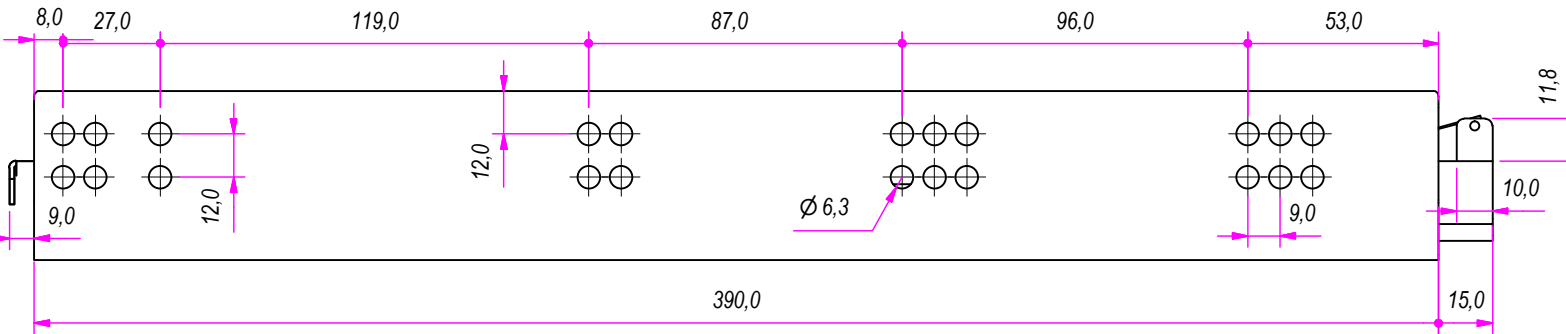
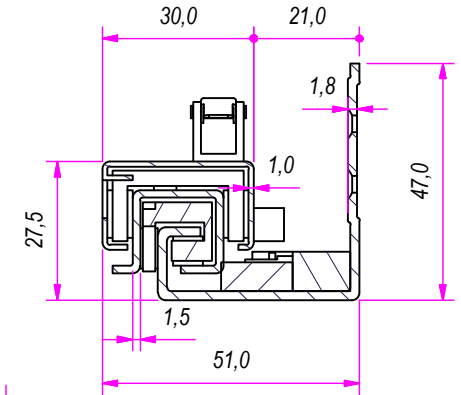

REVISION HISTORY		REV	DESCRIPTION	DATE
Guide per cassetti; guide telescopiche	Coulisses à billes; coulisse télescopique	1a		05/04/2017
Drawer slide; telescopic ball bearing slide	Guías para cajones; guía teleópica			
Kugelführung; Teleskopschienen				

Property of RAM Industrie.
Without its written authorization the present drawing shall neither be used for construction anyway, communicated to third parties, nor reproduced.

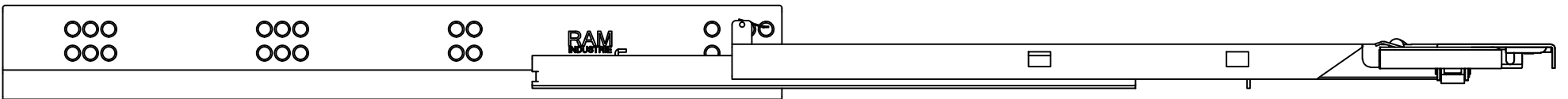
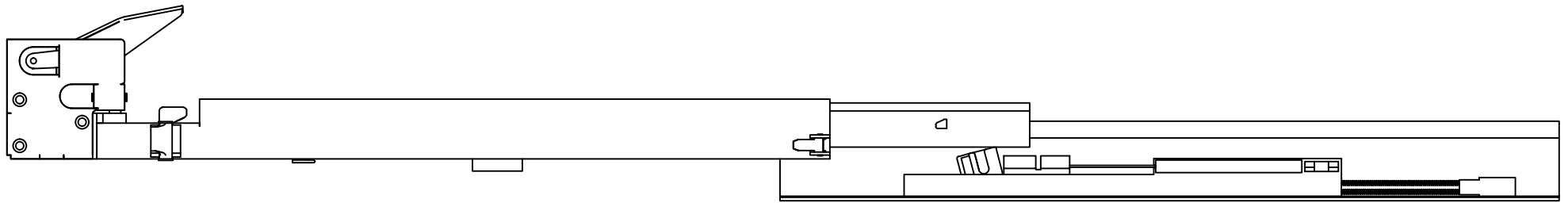
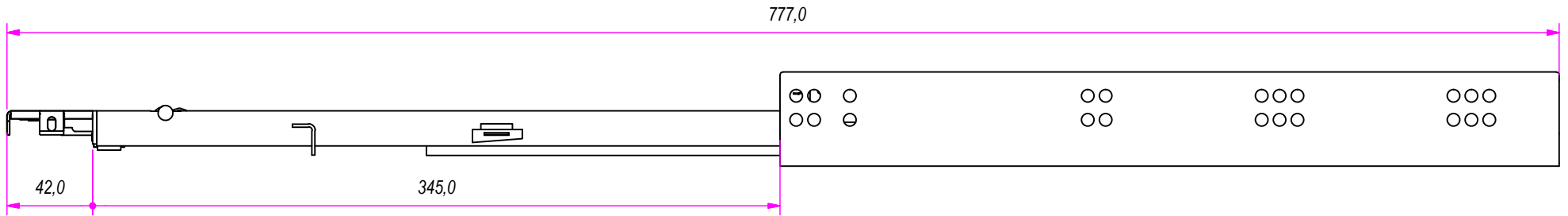
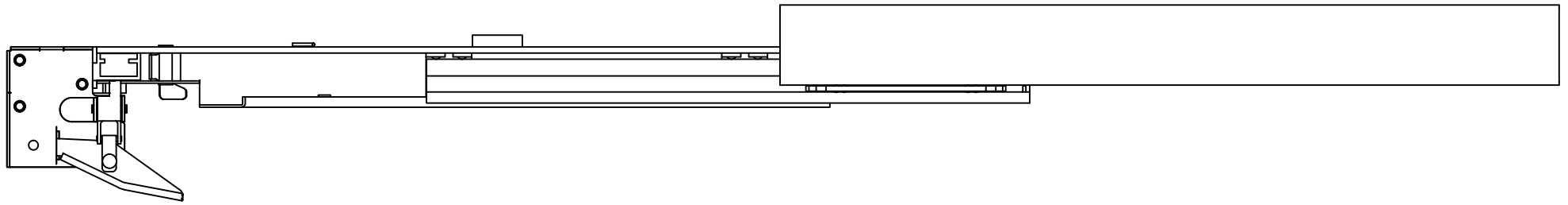

Guide per cassetti; guide telescopica	Coulisses à billes; coulisse télescopique
Drawer slide; telescopic ball bearing slide	Guías para cajones; guía teleópica
Kugelführung; Teleskopschienen	

REVISION HISTORY	
REV	DESCRIPTION
1a	

DESIGNED BY F. Dino	CHECKED AND APPROVED BY L. Paleari	GENERAL TOLERANCE SS-ISO-2768-1M	DATE 05/04/2017	CODE Q23400
		PACKAGING Carton 10 sets/Packed R+L	UNIT mm	SHEET 2 of 3
		DESCRIPTION Soft self closing/Oil piston/ Push&Rebound	MATERIAL Cold rolled steel	PAIR WEIGHT 2,06 Kg
Property of RAM Industrie.				
Without its written authorization the present drawing shall neither be used for construction anyway, communicated to third parties, nor reproduced.				

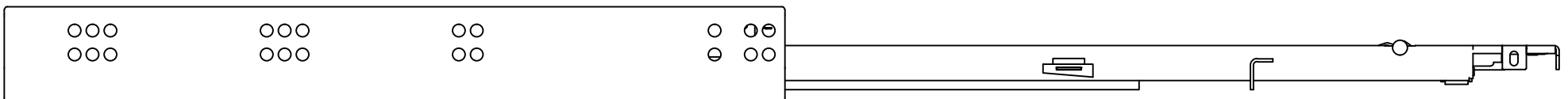
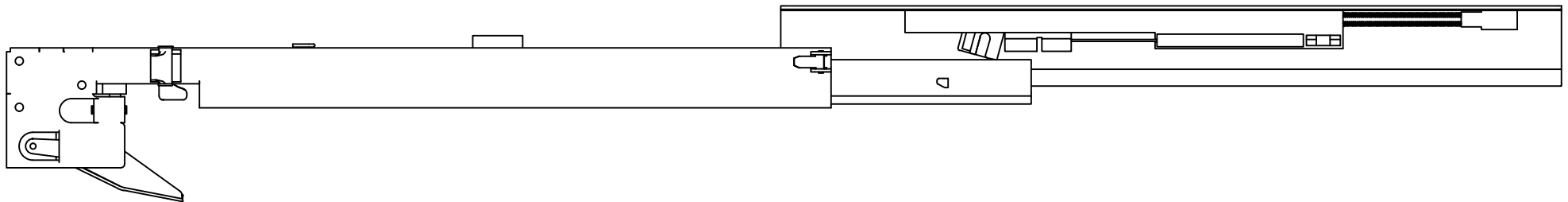
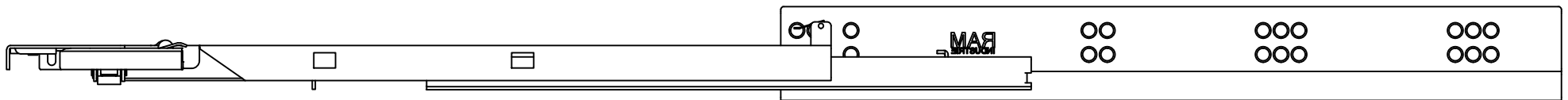
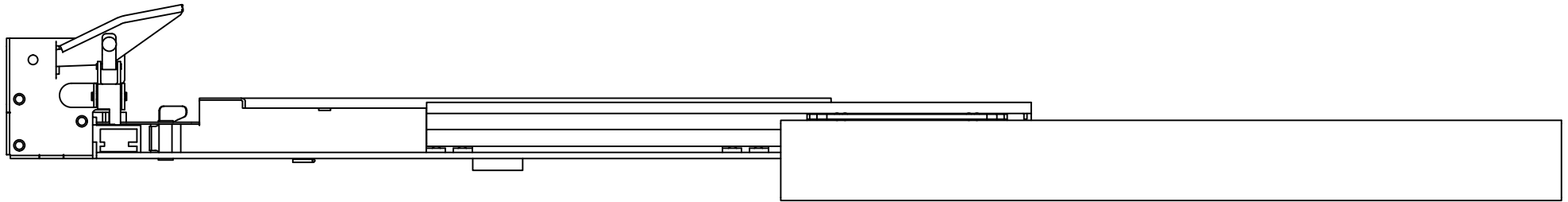

DESIGNED BY F.Dino	CHECKED AND APPROVED BY L. Paleari	GENERAL TOLERANCE SS-ISO-2768-1M	DATE 05/04/2017	CODE Q23400
PACKAGING Carton 10 sets/Packed R+L			UNIT mm	SHEET 3 of 3
			MATERIAL Cold rolled steel	
			DESCRIPTION Soft self closing/Oil piston/ Push&Rebound	PAIR WEIGHT 2,06 Kg

Property of RAM Industrie.
Without its written authorization the present drawing shall neither be used for construction anyway, communicated to third parties, nor reproduced.