

SEZ. A-A

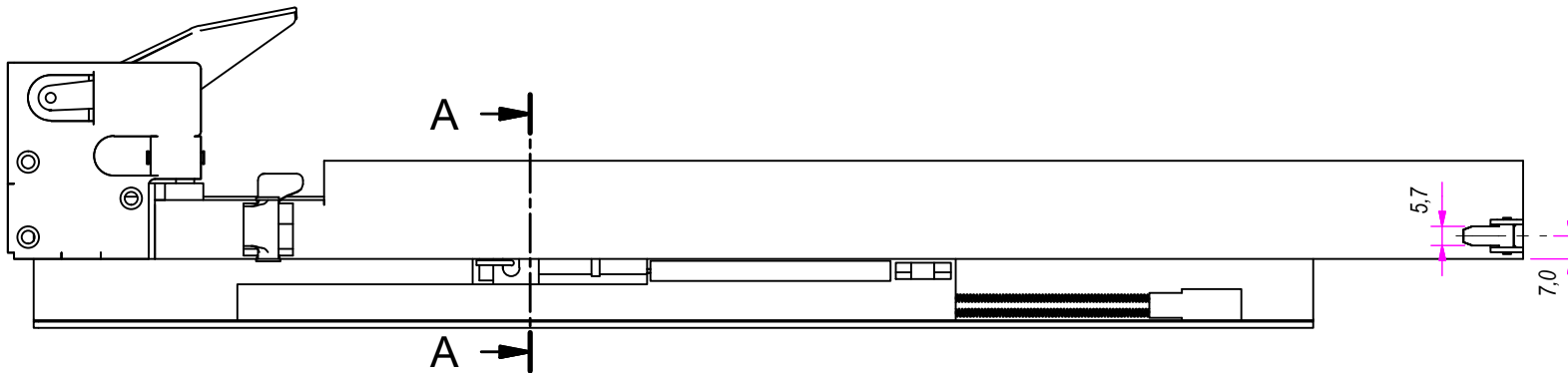
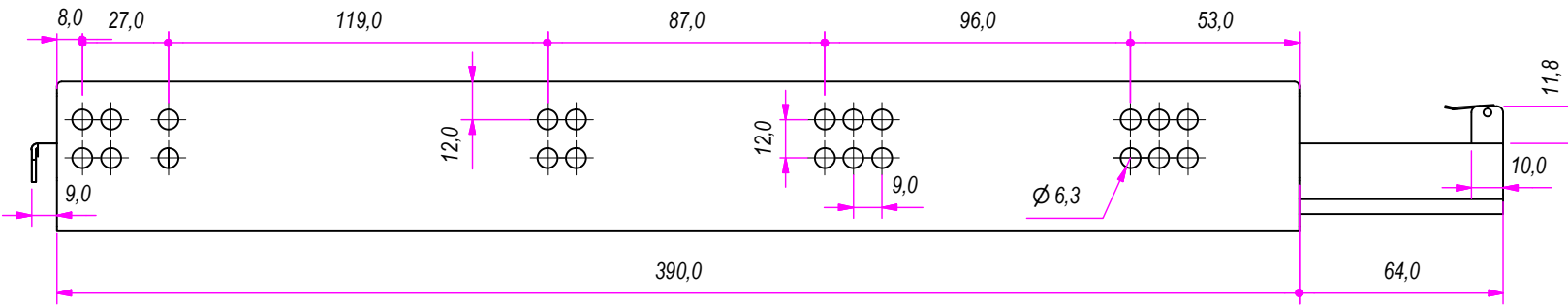
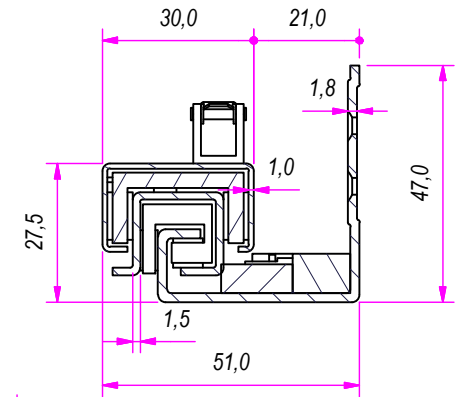

DESIGNED BY F. Dino	CHECKED AND APPROVED BY L. Paleari	GENERAL TOLERANCE SS-ISO-2768-1M	DATE 05/04/2017	CODE Q23450
PACKAGING Carton 10 sets/Packed R+L			UNIT mm	SHEET 1 of 3
DESCRIPTION Soft self closing/Oil piston/ Push&Rebound			MATERIAL Cold rolled steel	
			PAIR WEIGHT 2,148 Kg	04C

**RAM**  
**INDUSTRIE**

REVISION HISTORY		REV	DESCRIPTION	DATE
Guide per cassetti; guide telescopiche	Coulisses à billes; coulisse télescopique	1a		05/04/2017
Drawer slide; telescopic ball bearing slide	Guías para cajones; guía teleópica			
Kugelführung; Teleskopschienen				

Property of RAM Industrie.  
Without its written authorization the present drawing shall neither be used for construction anyway, communicated to third parties, nor reproduced.

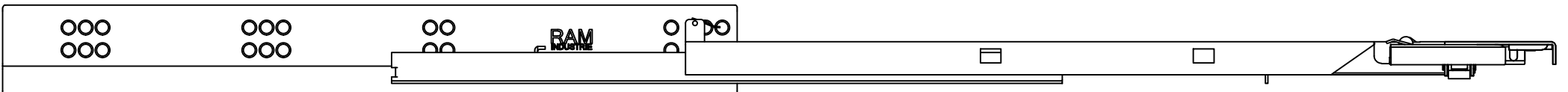
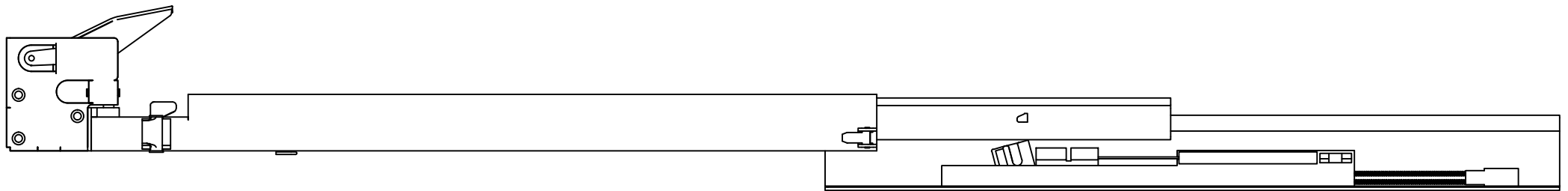
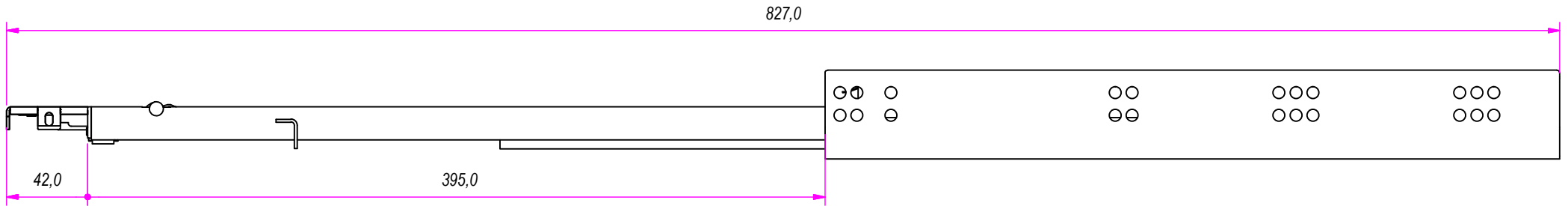
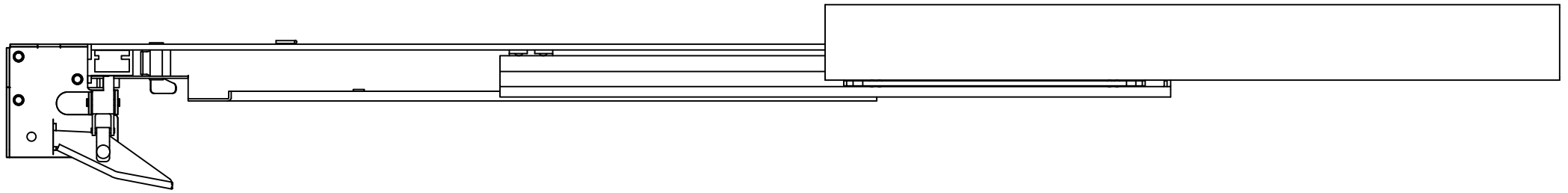

Guide per cassetti; guide telescopica	Coulisses à billes; coulisse télescopique
Drawer slide; telescopic ball bearing slide	Guías para cajones; guía teleópica
Kugelführung; Teleskopschienen	

REVISION HISTORY		
REV	DESCRIPTION	DATE
1a		05/04/2017

DESIGNED BY F. Dino	CHECKED AND APPROVED BY L. Paleari	GENERAL TOLLERANCE SS-ISO-2768-1M	DATE 05/04/2017	CODE Q23450	
			PACKAGING Carton 10 sets/Packed R+L	UNIT mm	SHEET 2 of 3
			DESCRIPTION Soft self closing/Oil piston/ Push&Rebound	MATERIAL Cold rolled steel	PAIR WEIGHT 2,148 Kg
Property of RAM Industrie.					
Without its written authorization the present drawing shall neither be used for construction anyway, communicated to third parties, nor reproduced.					

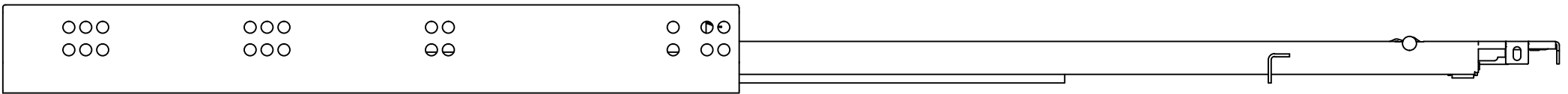
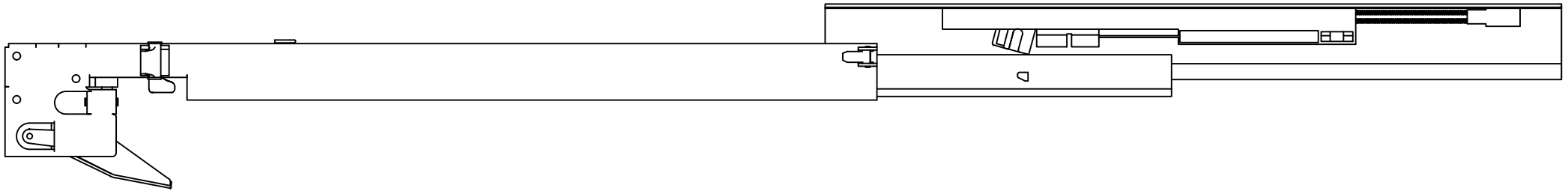
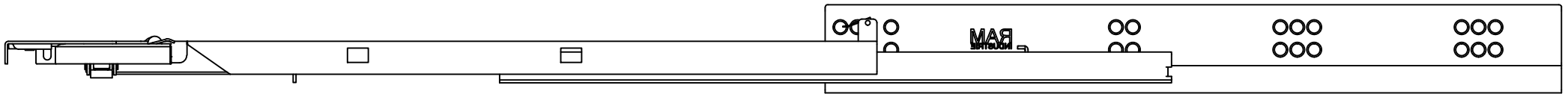
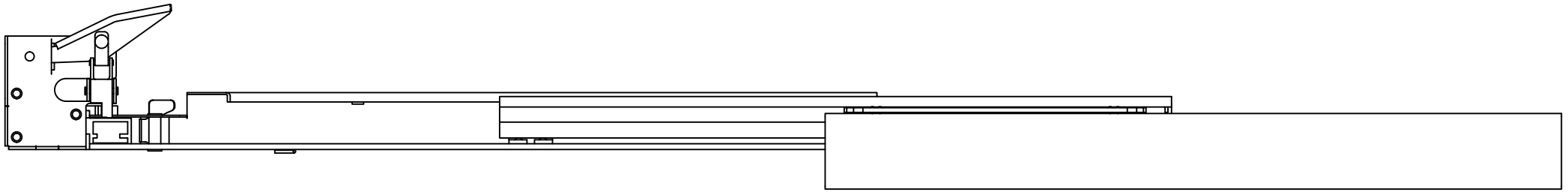

DESIGNED BY F.Dino	CHECKED AND APPROVED BY L. Paleari	GENERAL TOLLERANCE SS-ISO-2768-1M	DATE 05/04/2017	CODE Q23450
		PACKAGING Carton 10 sets/Packed R+L	UNIT mm	SHEET 3 of 3
		DESCRIPTION Soft self closing/Oil piston/ Push&Rebound	MATERIAL Cold rolled steel	PAIR WEIGHT 2,148 Kg
Property of RAM Industrie. Without its written authorization the present drawing shall neither be used for construction anyway, communicated to third parties, nor reproduced.				