

900,0

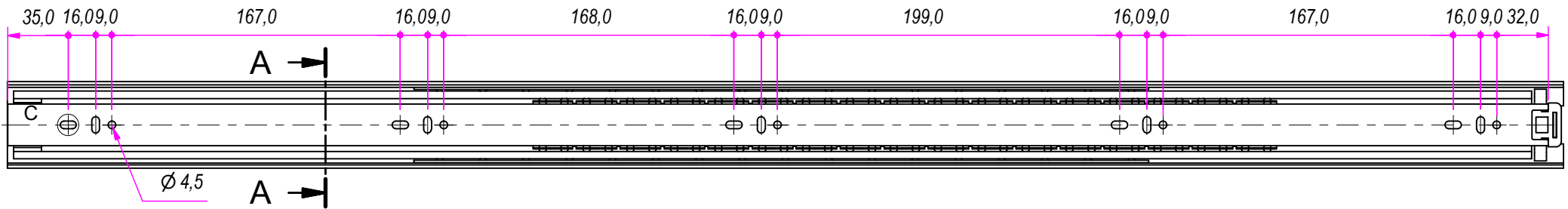

SEZ. A-A

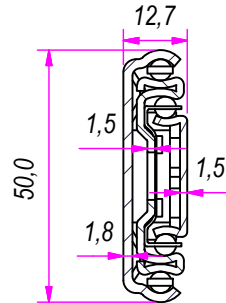

B (1:1)

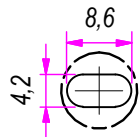

C (1:1)

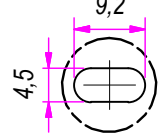

DESIGNED BY F.Dino	CHECKED AND APPROVED BY L. Paleari	REVISION	DATE 03/10/2016	CODE SH51900
		GENERAL TOLLERANCE SS-ISO-2768-1M	UNIT mm	SCALE 1 of 2
		DESCRIPTION	MATERIAL Cold rolled steel	
DEVICE		PAIR WEIGHT 3,74 Kg	02C	

REVISION HISTORY			
REV	DESCRIPTION	APPROVED BY	DATE
1		F.Dino	03/10/2016

Without its written authorization the present drawing shall neither be used for construction anyway, communicated to third parties, nor reproduced.

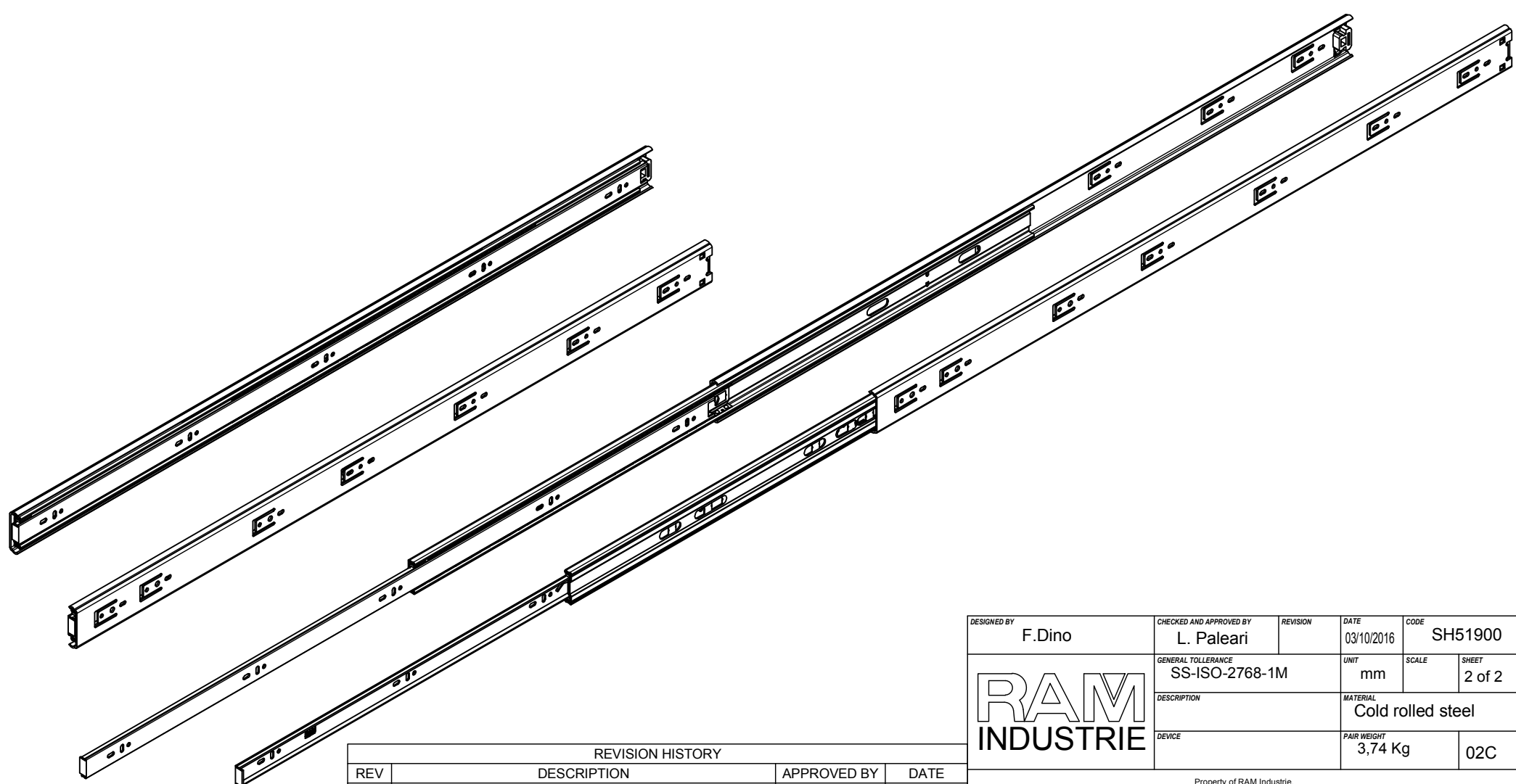
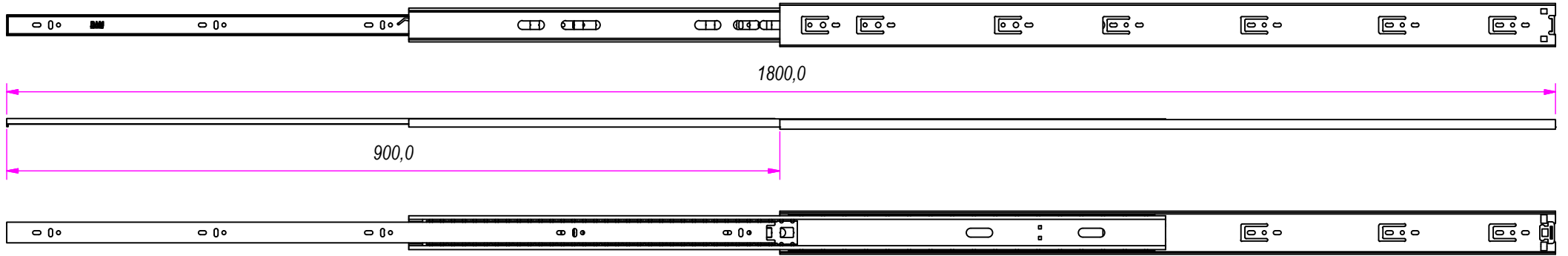

REVISION HISTORY			
REV	DESCRIPTION	APPROVED BY	DATE
1		F.Dino	03/10/2016

DESIGNED BY F.Dino	CHECKED AND APPROVED BY L. Paleari	REVISION	DATE 03/10/2016	CODE SH51900
		GENERAL TOLLERANCE SS-ISO-2768-1M	UNIT mm	SCALE SHEET 2 of 2
		DESCRIPTION	MATERIAL Cold rolled steel	
DEVICE		PAIR WEIGHT 3,74 Kg	02C	
Property of RAM Industrie. Without its written authorization the present drawing shall neither be used for construction anyway, communicated to third parties, nor reproduced.				