

REVISION HISTORY		
REV	DESCRIPTION	DATE
1a		11/06/2018

DESIGNED BY F. Dino	CHECKED AND APPROVED BY L. Paleari	GENERAL TOLERANCE SS-ISO-2768-1M	DATE 11/06/2018	CODE T491000B
PACKAGING Carton 1 piece			UNIT mm	SHEET 1 of 4
DESCRIPTION RAM INDUSTRIE			MATERIAL Anodise aluminum alloy 6060	
DEVICE Side synchronized movement			PAIR WEIGHT 12,2 Kg	021
Property of RAM Industrie. Without its written authorization the present drawing shall neither be used for construction anyway, communicated to third parties, nor reproduced.				

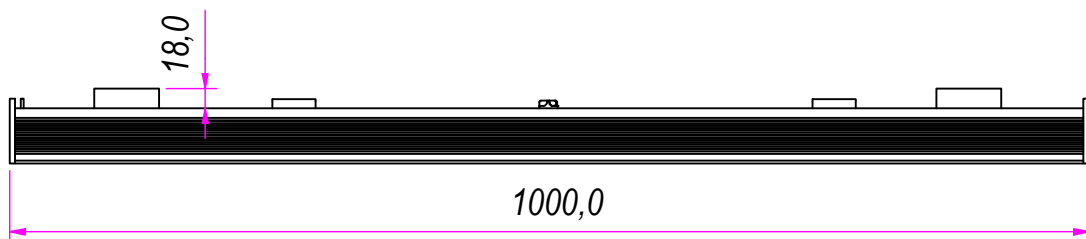
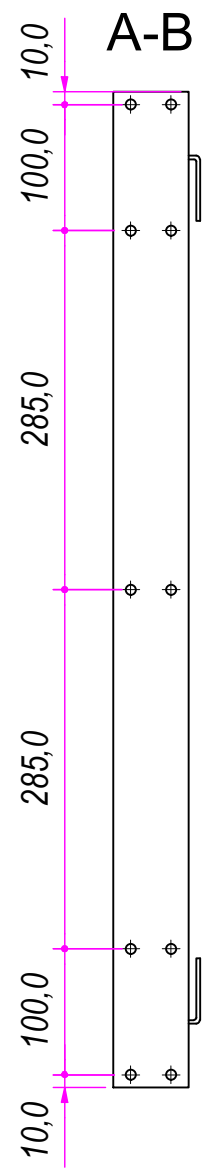
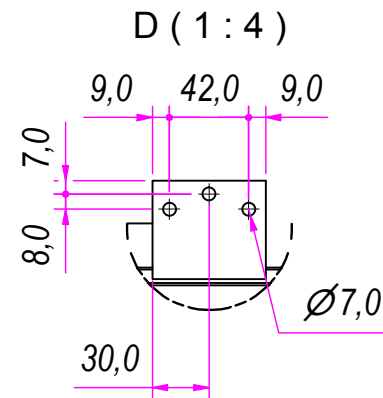
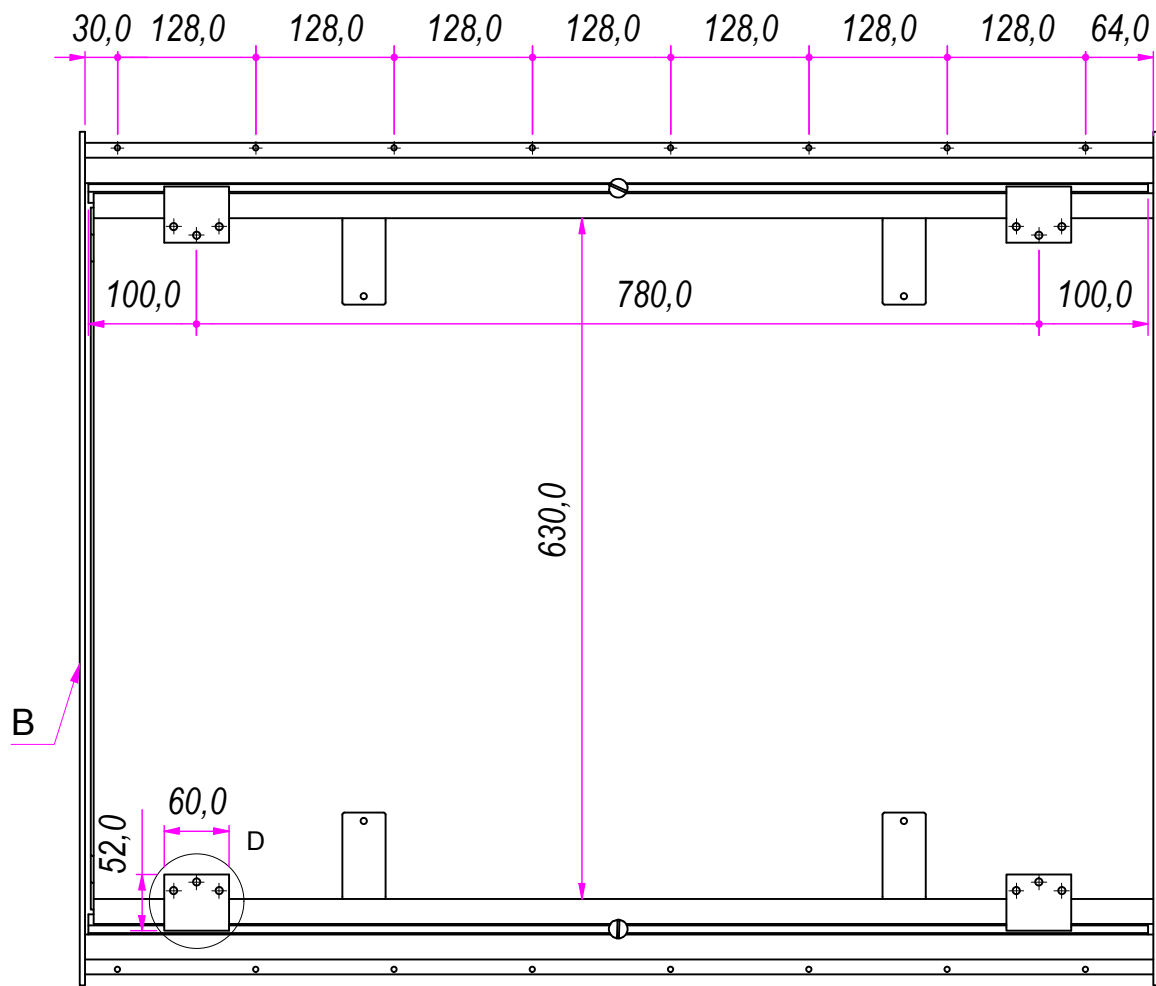

DESIGNED BY F.Dino	CHECKED AND APPROVED BY L. Paleari	GENERAL TOLERANCE SS-ISO-2768-1M	DATE 11/06/2018	CODE T491000B
PACKAGING Carton 1 piece			UNIT mm	SHEET 2 of 4
DESCRIPTION RAM INDUSTRIE			MATERIAL Anodise aluminum alloy 6060	
DEVICE Side synchronized movement			PAIR WEIGHT 12,2 Kg	021

REVISION HISTORY		
REV	DESCRIPTION	DATE
1a		11/06/2018

Property of RAM Industrie.
Without its written authorization the present drawing shall neither be used for construction anyway, communicated to third parties, nor reproduced.

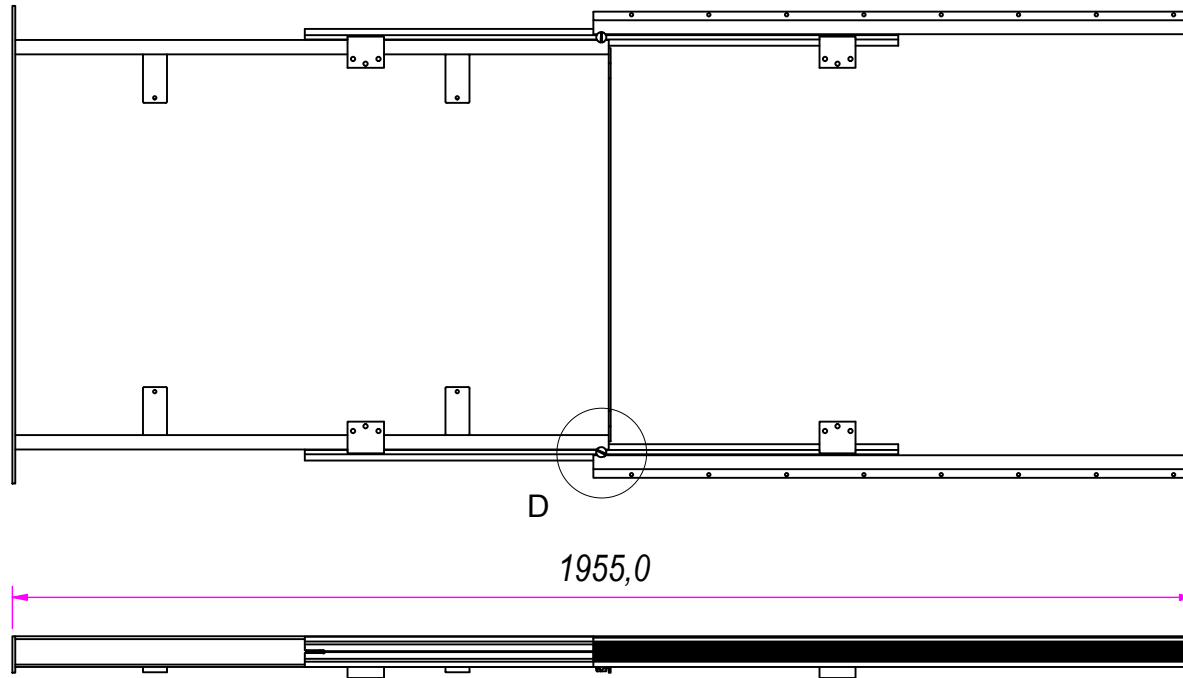

D (1 : 5)

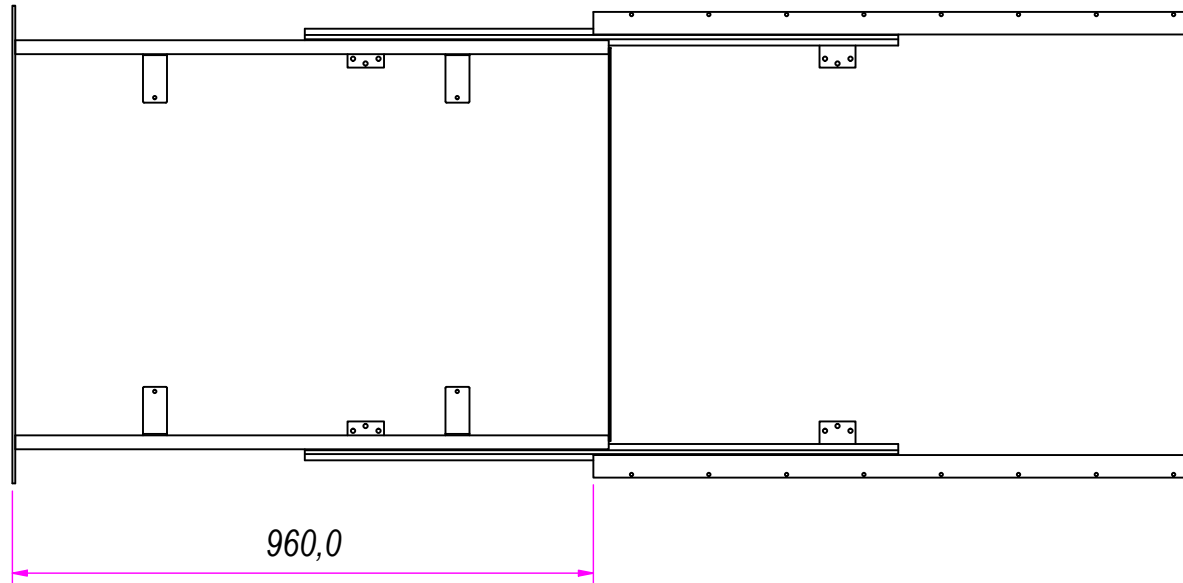
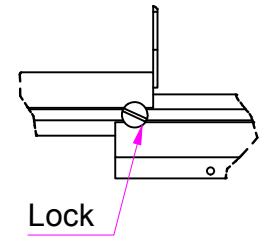



REVISION HISTORY		
REV	DESCRIPTION	DATE
1a		11/06/2018

DESIGNED BY F.Dino	CHECKED AND APPROVED BY L. Paleari	GENERAL TOLERANCE SS-ISO-2768-1M	DATE 11/06/2018	CODE T491000B
PACKAGING Carton 1 piece			UNIT mm	SHEET 3 of 4
DESCRIPTION Side synchronized movement			MATERIAL Anodise aluminum alloy 6060	
			PAIR WEIGHT 12,2 Kg	021

RAM
INDUSTRIE

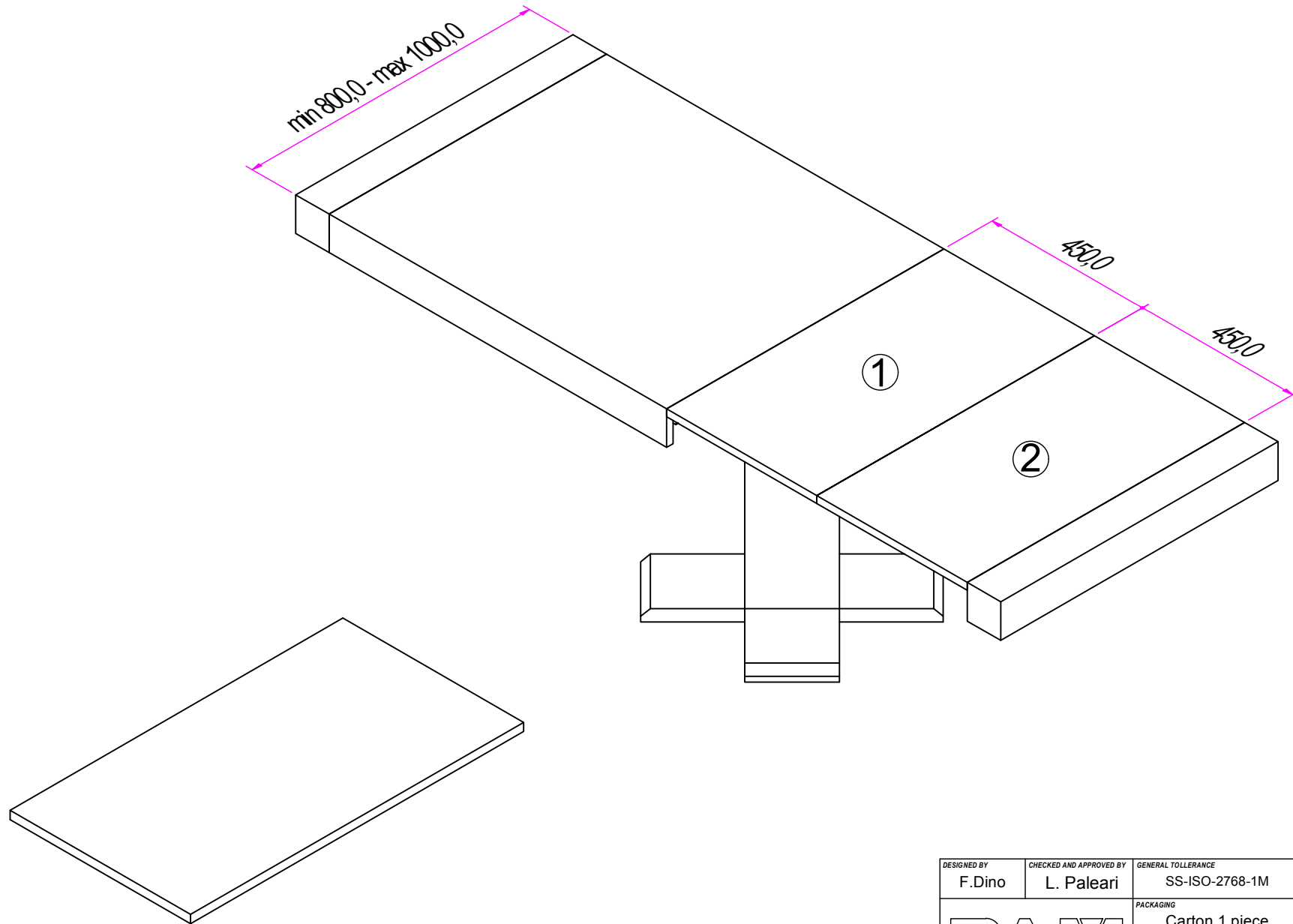
Property of RAM Industrie.
Without its written authorization the present drawing shall neither be used for construction anyway, communicated to third parties, nor reproduced.



DESIGNED BY F.Dino	CHECKED AND APPROVED BY L. Paleari	GENERAL TOLLERANCE SS-ISO-2768-1M	DATE 11/06/2018	CODE T491000B
PACKAGING Carton 1 piece			UNIT mm	SHEET 4 of 4
			MATERIAL Anodise aluminum alloy 6060	
			DEVICE Side synchronized movement	PAIR WEIGHT 12,2 Kg

Property of RAM Industrie.
Without its written authorization the present drawing shall neither be used for construction anyway, communicated to third parties, nor reproduced.