

REVISION HISTORY		
REV	DESCRIPTION	DATE
1a		11/06/2018

DESIGNED BY F. Dino	CHECKED AND APPROVED BY L. Paleari	GENERAL TOLERANCE SS-ISO-2768-1M	DATE 11/06/2018	CODE T491300A
PACKAGING Carton 1 piece			UNIT mm	SHEET 1 of 4
DESCRIPTION RAM INDUSTRIE			MATERIAL Anodise aluminum alloy 6060	
DEVICE Side synchronized movement			PAIR WEIGHT 13,5 Kg	021
Property of RAM Industrie. Without its written authorization the present drawing shall neither be used for construction anyway, communicated to third parties, nor reproduced.				

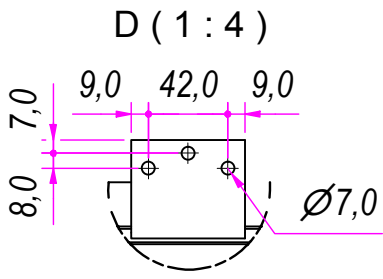
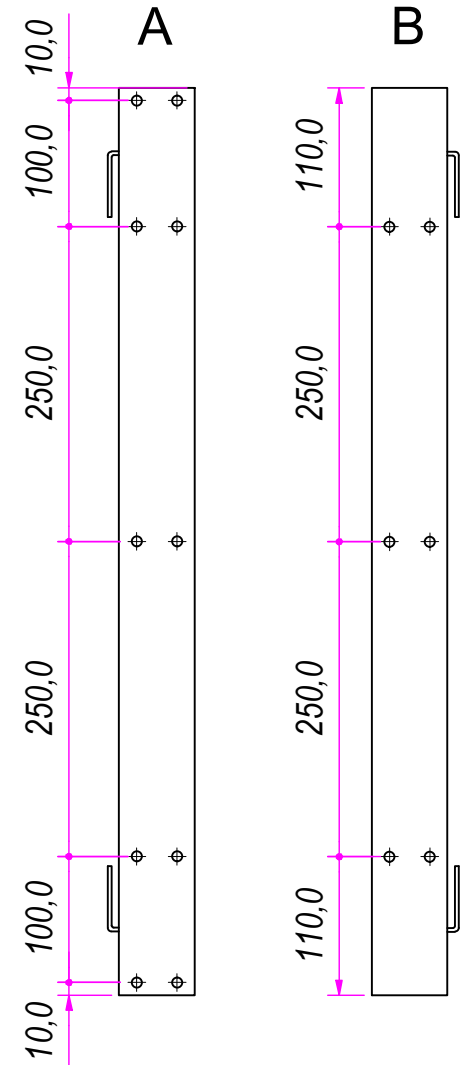
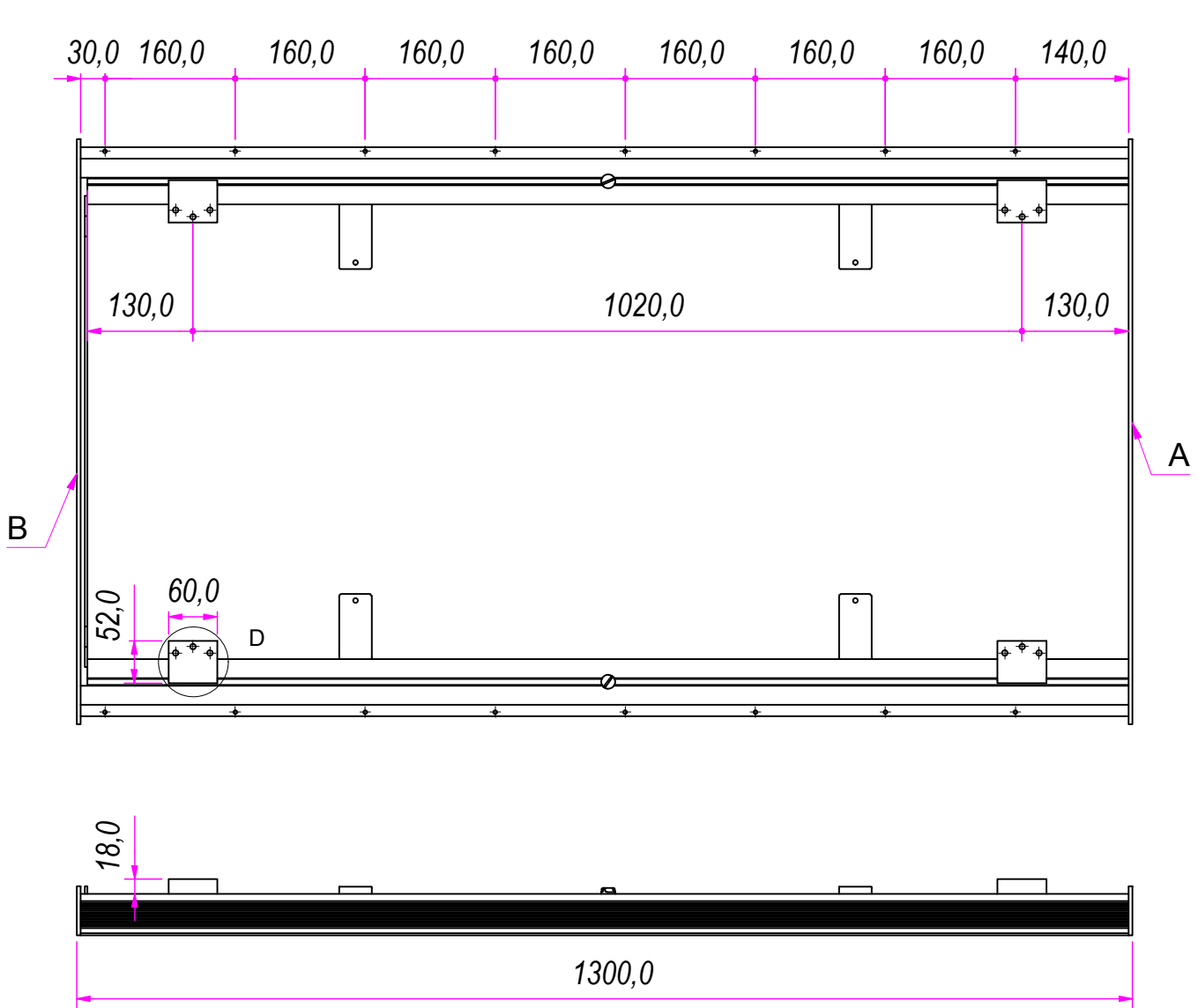

REVISION HISTORY		
REV	DESCRIPTION	DATE
1a		11/06/2018

DESIGNED BY F.Dino	CHECKED AND APPROVED BY L. Paleari	GENERAL TOLLERANCE SS-ISO-2768-1M	DATE 11/06/2018	CODE T491300A
PACKAGING Carton 1 piece			UNIT mm	SHEET 2 of 4
DESCRIPTION RAM INDUSTRIE			MATERIAL Anodise aluminum alloy 6060	
DEVICE Side synchronized movement			PAIR WEIGHT 13,5 Kg	021
Property of RAM Industrie. Without its written authorization the present drawing shall neither be used for construction anyway, communicated to third parties, nor reproduced.				

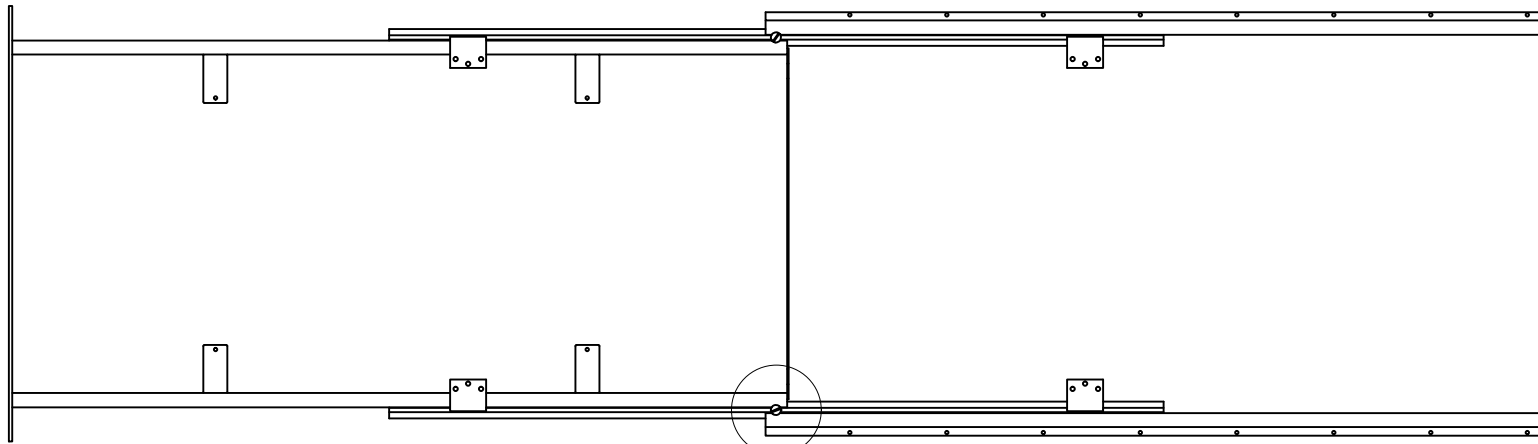

D

2545,0

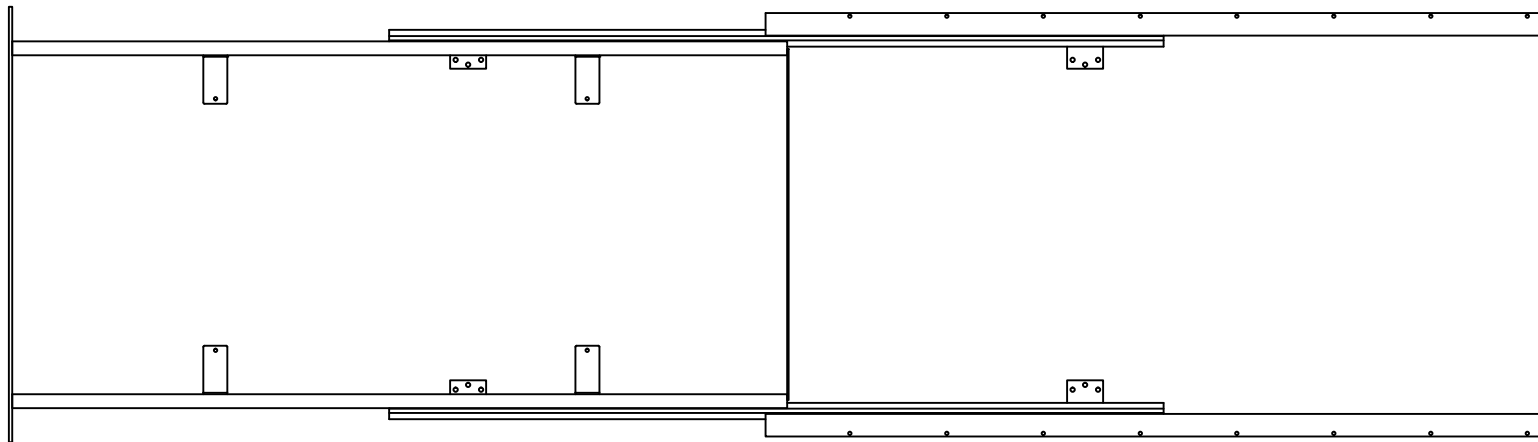
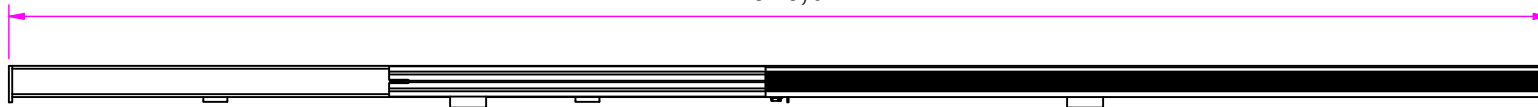

1250,0

D (1 : 5)

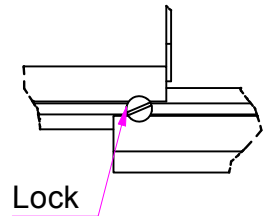



REVISION HISTORY		
REV	DESCRIPTION	DATE
1a		11/06/2018

DESIGNED BY F.Dino	CHECKED AND APPROVED BY L. Paleari	GENERAL TOLERANCE SS-ISO-2768-1M	DATE 11/06/2018	CODE T491300A
PACKAGING Carton 1 piece			UNIT mm	SHEET 3 of 4
DESCRIPTION Side synchronized movement		MATERIAL Anodise aluminum alloy 6060		
PAIR WEIGHT 13,5 Kg		021		

RAM
INDUSTRIE

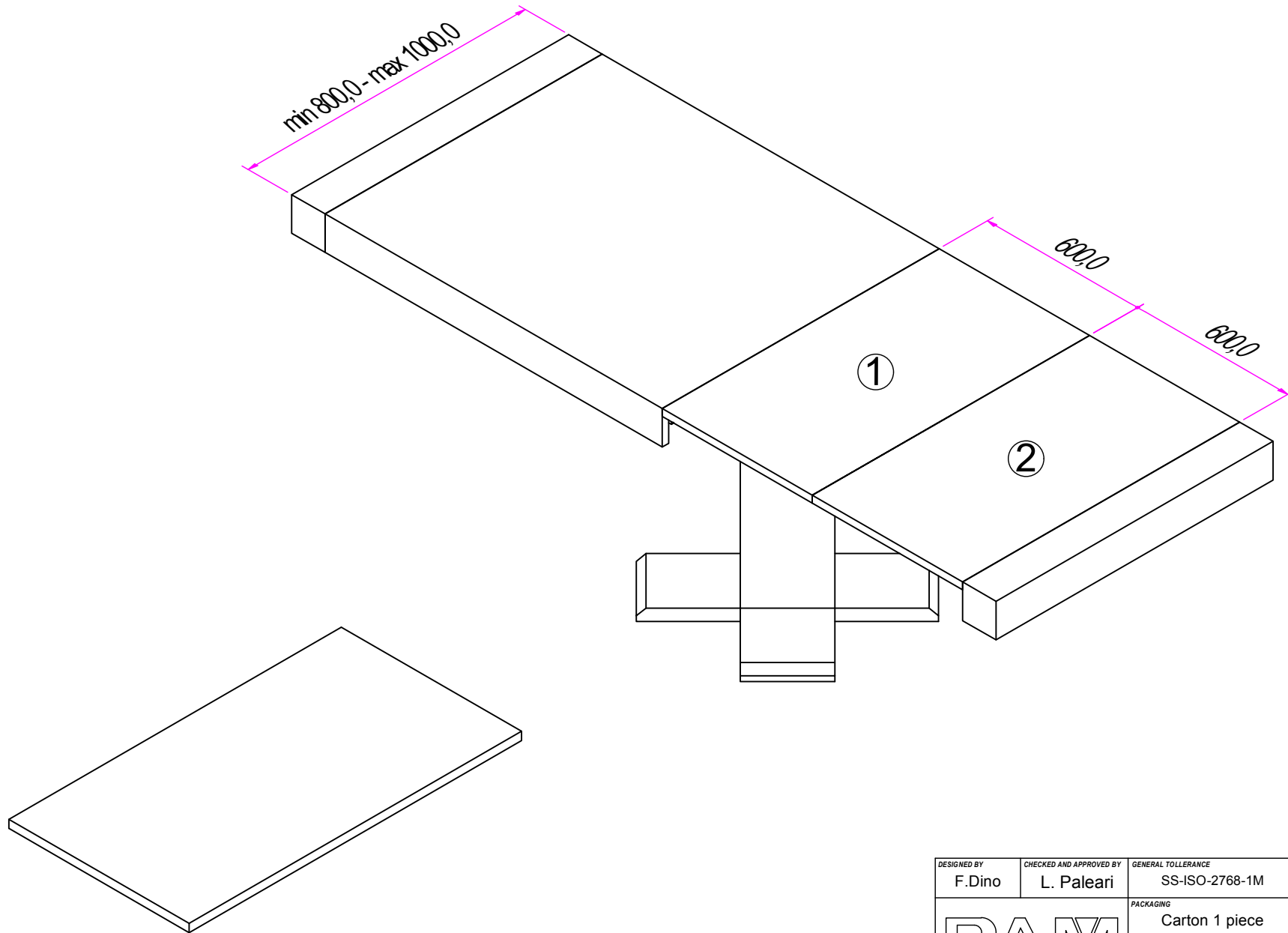
Property of RAM Industrie.
Without its written authorization the present drawing shall neither be used for construction anyway, communicated to third parties, nor reproduced.



DESIGNED BY F. Dino	CHECKED AND APPROVED BY L. Paleari	GENERAL TOLLERANCE SS-ISO-2768-1M	DATE 11/06/2018	CODE T491300A
PACKAGING Carton 1 piece			UNIT mm	SHEET 4 of 4
			DESCRIPTION Anodise aluminum alloy 6060	
			DEVICE Side synchronized movement	PAIR WEIGHT 13,5 Kg

Property of RAM Industrie.
Without its written authorization the present drawing shall neither be used for construction anyway, communicated to third parties, nor reproduced.